



XDVD8182

INSTALLATION/OWNER'S MANUAL

DVD Multimedia Receiver with 7" Touch Screen Display



Safety Notes:

The DVD video display of the in-dash unit will not operate while the vehicle is moving. This is a safety feature to prevent driver distraction. In-dash DVD video functions will only operate when vehicle is in Park and the parking brake is engaged. It is illegal in most states for the driver to view video while the vehicle is in motion.

Copyright Notes

This product incorporates copyright protection technology that is protected by method claims of certain U.S. patents and other intellectual property rights owned by Macrovision Corporation and other rights owners. Use of this copyright protection technology must be authorized by Macrovision Corporation, and is intended for home and other limited viewing uses only unless otherwise authorized by Macrovision Corporation. Reverse engineering or disassembly is prohibited.

Manufactured under license from Dolby Laboratories. Dolby, Pro Logic and the double-D symbol are trademarks of Dolby Laboratories.

Windows Media and the Windows logo are trademarks, or registered trademarks of Microsoft Corporation in the United States and or other countries.

All other trademarks are property of their respective owners.



Table of Contents

	Page
DVD Region Management	2
Warning Statement	3
Safety Information/Precautions	4
Preparation/Mounting/Wiring	5-7
Remote Control Overview	8
Control Locations - Monitor Closed	9-10
Control Locations - Monitor Open	11-12
Control Locations - Remote	13-14
General Operation	15-20
General Setup Menu	21-22
Setting the Clock	23
Anti-theft Code	24
Screen Setup	25-28
AM/FM Tuner Operation	29-30
Warning Statement	31
DVD Operation	32-39
DVD Setup	40-48
CD Operation	49-50
MP3/WMA Operation	51-52
Media Compatibility Information	53-54
Warranty	55
Troubleshooting	56
Specifications	57

DVD Region Management

Some DVD discs can be played only in certain playback modes according to the intentions of the software. As the XDVD8182 plays discs according to their intentions, some functions may not work as intended. Please be sure to read the instructions provided with each disc. This player has been designed to play back DVD software that has been encoded for specific region areas. It cannot play back DVD software encoded for other region areas than the region areas for which it has been designed.

The XDVD8182 will play discs labeled "Region 1" or "All".

DVD region codes:

- 1 - USA, Canada
- 2 - Japan, Europe, South Africa, Middle East
- 3 - Rep. of Korea, Taiwan, Hong Kong, Parts of Southeast Asia
- 4 - Australia, New Zealand, Mexico, South America
- 5 - Eastern Europe, Russia, India, Africa
- 6 - China





XDVD8182 PREPARATION

⚠ WARNING ⚠

Upon installation of this Monitor/DVD player (“unit”) into a vehicle, the driver of the vehicle must not operate this unit by watching videos or playing video games while driving. Failure to follow this instruction could lead to driver distraction which could result in serious injury or death to the vehicle’s occupants or persons outside the vehicle and/or property damage.

Several states prohibit the installation of monitors/DVD players if the screen is visible from the driver’s seat. If you reside in a jurisdiction which has enacted such a law, this unit must not be installed so that the screen is visible from the driver’s seat. When installing this unit in the front console/dashboard, the unit must be positioned so that it is facing the front passenger seat only. Failure to follow this instruction could lead to driver distraction which could result in serious injury or death to the vehicle’s occupants or persons outside the vehicle and/or property damage.

This unit is designed so that it may be operated only when the vehicle is in “Park” and the parking brake is fully engaged. To this end, this unit includes a parking brake lock-out feature which prohibits the unit from operating if the vehicle is not in “Park” and/or the parking brake is not fully engaged. When installing this unit, the installer must connect the parking brake detect wire (“Yellow-Blue Lead”) to the parking brake mechanism in order to make the parking brake lock-out feature operable. DO NOT simply ground the parking brake detect wire to a metal portion of the vehicle. Failure to properly install the parking brake lock-out feature could lead to driver distraction which could result in serious injury or death to the driver’s occupants or persons outside the vehicle and/or property damage.

Once the parking brake lock-out feature is installed, the owner/user must not attempt to disrupt/neutralize the parking brake lock-out feature by (a) partially engaging the parking brake and/or (b) purchasing/using any device or unit designed to send necessary brake signals to the unit. Failure to follow these instructions could lead to driver distraction which could result in serious injury or death to the driver’s occupants or persons outside the vehicle and/or property damage.

When operating this unit, keep the unit’s volume level low enough so that the vehicle’s occupants can hear traffic-related sounds such as police and emergency vehicles. Failure to follow this instruction could lead to driver distraction which could result in serious injury or death to the vehicle’s occupants or persons outside the vehicle and/or property damage.

Safety Information

Please read all instructions carefully before attempting to install or operate.

Due to its technical nature, it is highly recommended that your DUAL XDVD8182 is installed by a professional installer or an authorized dealer. This product is only for use in vehicles with 12VDC negative ground only.

Safety Notes:

The DVD video display of the in-dash unit will not operate while the vehicle is moving. This is a safety feature to prevent driver distraction. In-dash DVD video functions will only operate when vehicle is in Park and the parking brake is engaged. It is illegal in most states for the driver to view video while the vehicle is in motion.

To prevent damage or injury:

1. Make sure to ground the unit securely to the vehicle chassis ground.
2. Do not remove the top or bottom covers of the unit.
3. Do not install the unit in a spot exposed to direct sunlight or excessive heat or the possibility of water splashing.
4. Do not subject the unit to excessive shock.
5. When replacing a fuse, only use a new one with the prescribed rating. Using a fuse with the wrong rating may cause the unit to malfunction.
6. To prevent short circuits when replacing a fuse, disconnect the wiring harness first.
7. Use only the provided hardware and wire harness.
8. You cannot view video while the vehicle is moving. Find a safe place to park and engage the parking brake.
9. If you experience problems during installation, consult your nearest DUAL dealer.
10. If the unit malfunctions, reset the unit as described on page 12 first. If the problem still persists, consult your nearest DUAL dealer or call tech assistance @ 1-866-382-5476.
11. To clean the monitor, wipe only with a dry silicone cloth or soft cloth. Do not use a stiff cloth, or volatile solvents such as paint thinner and alcohol. They can scratch the surface of the panel and/or remove the printing.
12. When the temperature of the unit falls (as in winter), the liquid crystal inside the screen will become darker than usual. Normal brightness will return after using the monitor for a while.

Additional Notes:

1. When extending the ignition, battery or ground cables, make sure to use automotive-grade cables or other cables with an area of 0.75mm (AWG 18) or more to prevent voltage drops.
2. Do not touch the liquid crystal fluid if the LCD is damaged or broken. The liquid crystal fluid may be hazardous to your health or fatal. If the liquid crystal fluid from the LCD contacts your body or clothing, wash it off with soap immediately.

This device complies with part 15 of the FCC rules and regulations.

Operation is subject to the following two conditions:

- 1) This device may not cause harmful interference, and
- 2) This device must accept any interference received, including interference that may cause undesired operation.

Preparation

Please read entire manual before installation.

Before You Start

- Disconnect negative battery terminal. Consult a qualified technician for instructions.
- Avoid installing the unit where it would be subject to high temperatures, such as from direct sunlight, or where it would be subject to dust, dirt or excessive vibration.

Getting Started

- Slide the unit out of the mounting sleeve.
- Install mounting sleeve into opening, bending tabs to secure.
- Connect wiring harness and antenna as shown on pages 6-7. Consult a qualified technician if you are unsure.
- Certain vehicles may require an installation kit and/or wiring harness adapter (sold separately).
- Test for correct operation and slide unit into mounting sleeve.
- Attach unit to mounting sleeve using supplied #1 Phillips screws.
- Snap trim ring into place.
- Mount the iplug™ adapter to any smooth clean surface using the supplied double-sided tape or Phillips head screws.

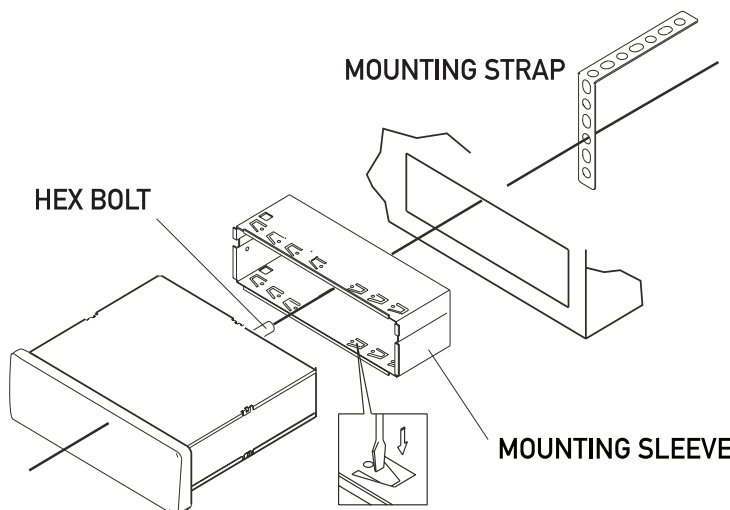
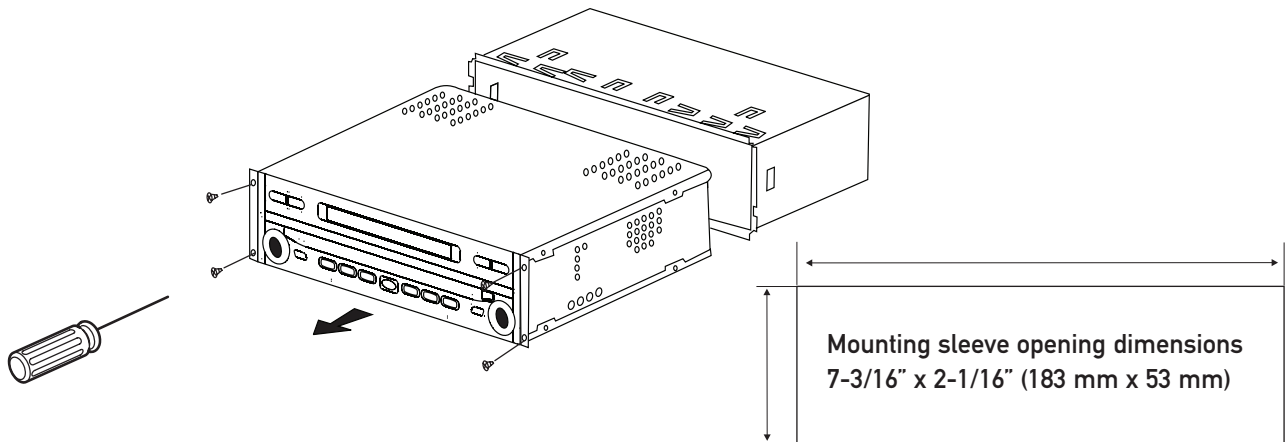

TYPICAL FRONT-LOAD DIN MOUNTING METHOD

Expanded Wiring Diagram - Inputs/Outputs

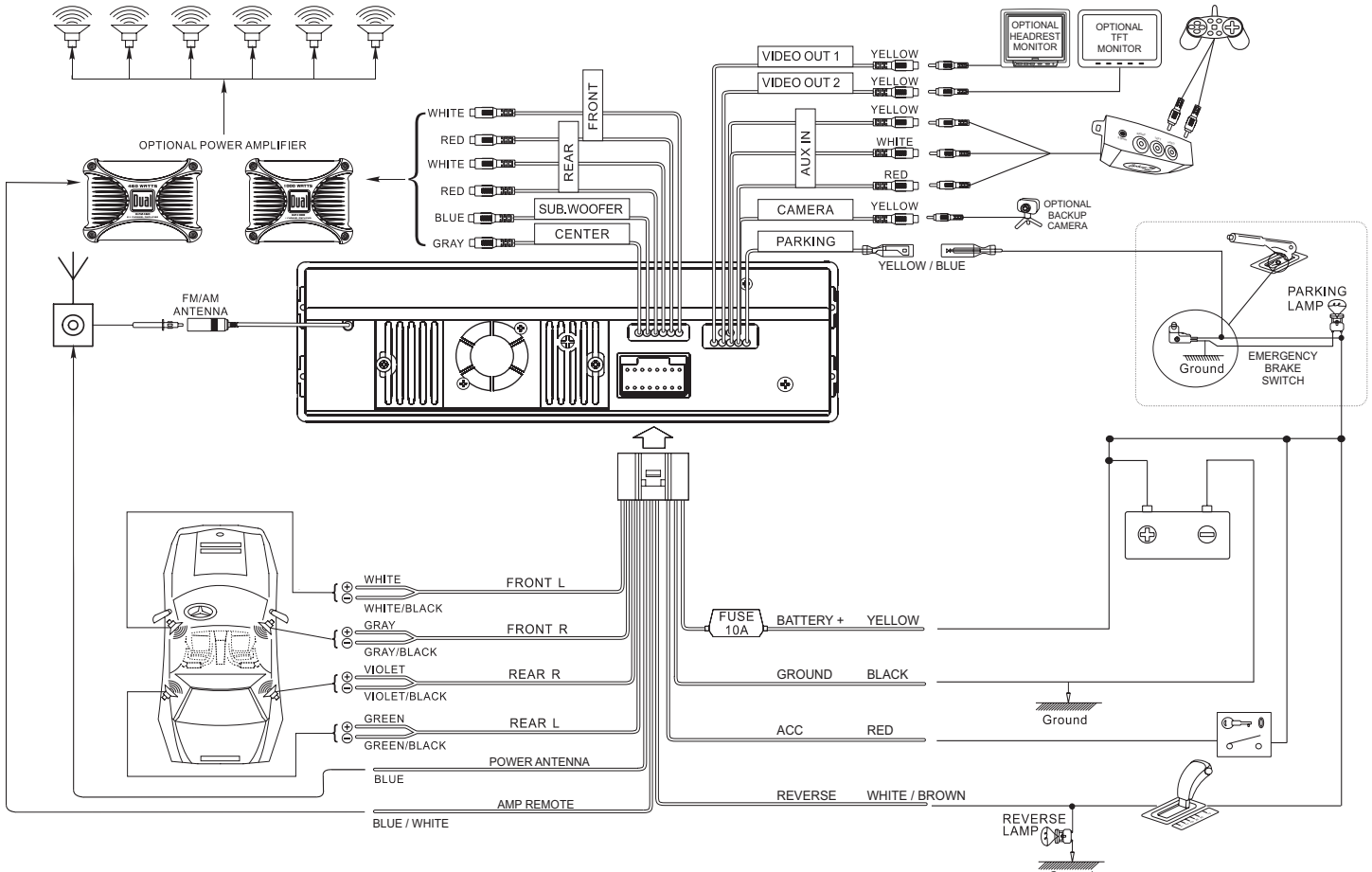

Wiring Notes:

Subwoofer output

The **SUBWOOFER** audio output (Blue RCA) is active in all audio modes and must be connected to an external amplifier.

Center output

The **CENTER** audio output (Gray RCA) is only active in DVD 5.1 and Dolby Pro Logic II audio modes and must be connected to an external amplifier.

Rear view camera

A rear view camera (not included) can be used with the **CAMERA** input.

NEED HELP??

Call our Technical Service Hotline, 1-866-382-5476.

Safety Notes:

The DVD video display of the in-dash unit will not operate while the vehicle is moving. This is a safety feature to prevent driver distraction. In-dash DVD video functions will only operate when vehicle is in Park and the parking brake is engaged. It is illegal in most states for the driver to view video while the vehicle is in motion. Altering or defeating this safety feature is a violation of law and is prohibited.

Wiring Diagram - Optional A/V Connections

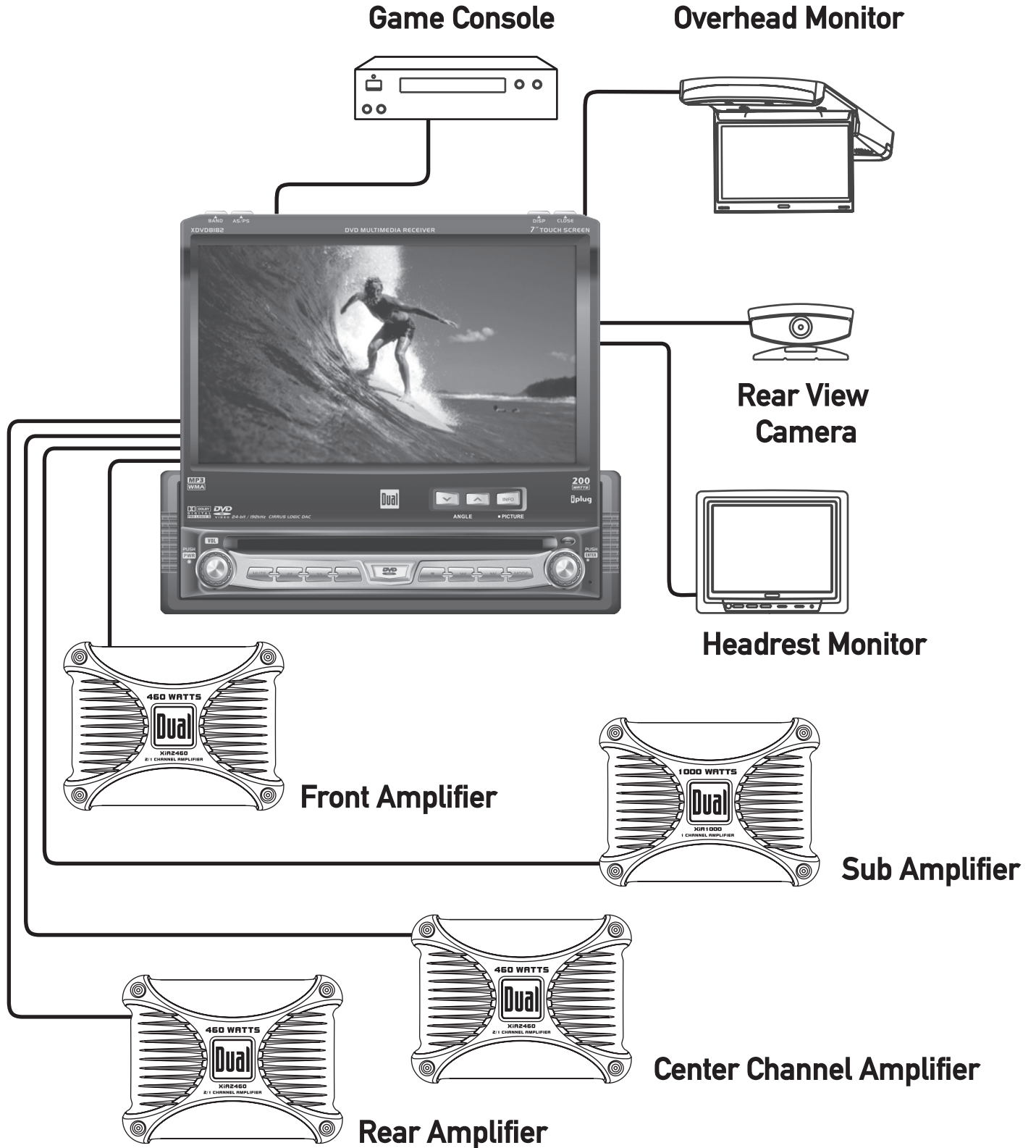

IR Remote Preparation

To first use the IR Remote control, you must first pull the battery insulation tape out

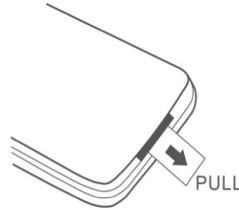

Notes:

- Remove the battery if the remote will not be used for a month or longer
- Remove and dispose of battery properly

Insert or replacing the Battery:

Remove the battery holder

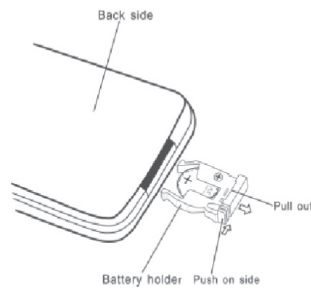

Remove the battery from the battery holder

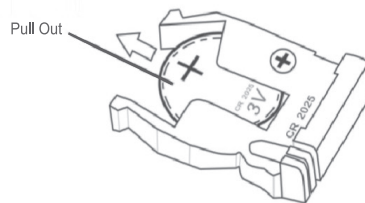

Install the new battery
Make sure to keep the (+) side up

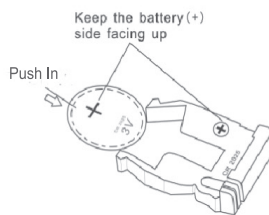

Insert the battery holder

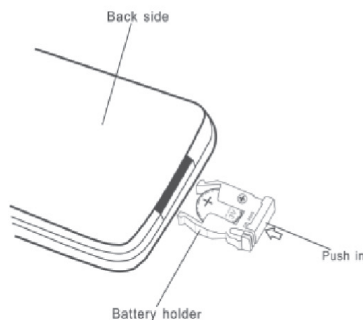

CAUTION!!!

- Do not store battery with metallic objects or materials

Control Locations - Monitor Closed

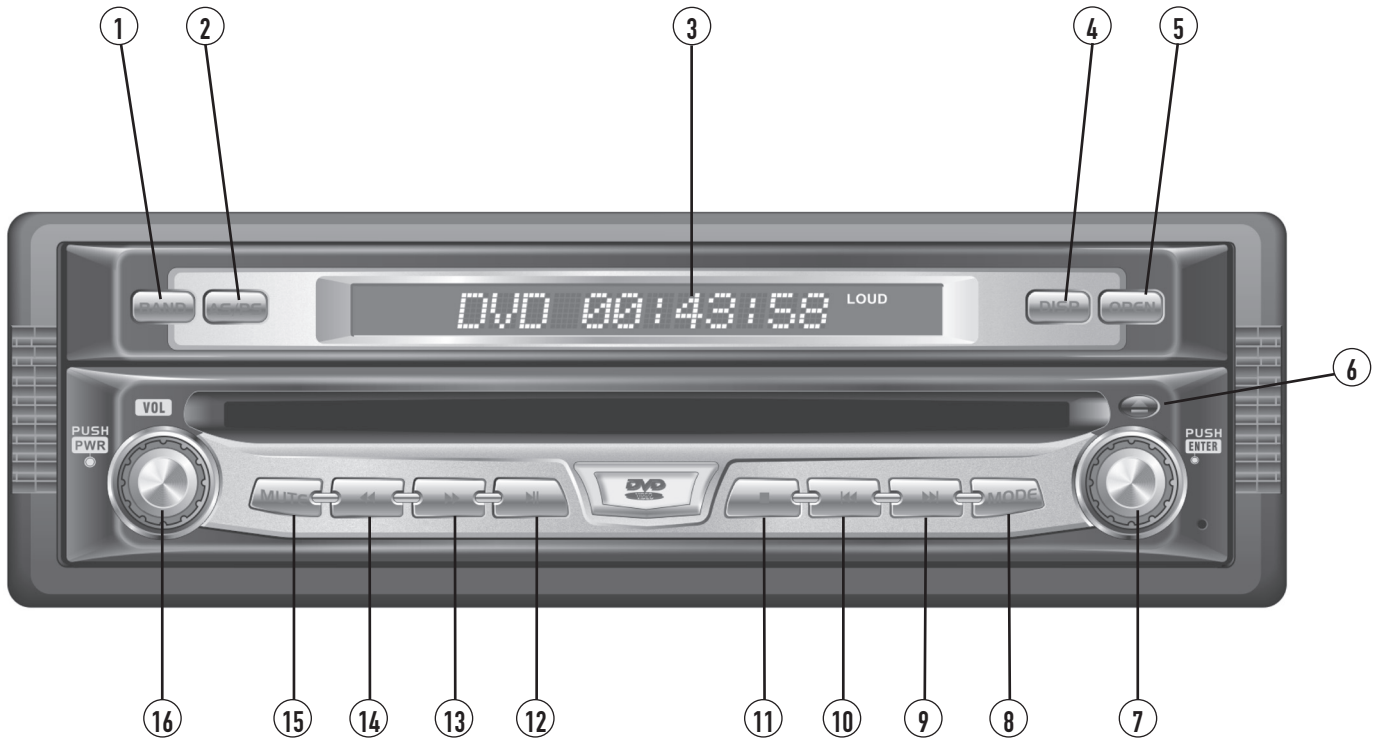

- | | |
|--------------------------|----------------------|
| ① Band | ⑨ Chapter/Track Up |
| ② Auto Store/Preset Scan | ⑩ Chapter/Track Down |
| ③ Secondary LCD | ⑪ Stop |
| ④ Display | ⑫ Play/Pause |
| ⑤ Open/Close Monitor | ⑬ Fast Forward |
| ⑥ Eject | ⑭ Fast Reverse |
| ⑦ Rotary Encoder/Enter | ⑮ Mute |
| ⑧ Mode | ⑯ Power/Volume |

Monitor Notes:

- This model incorporates a motorized moving monitor. Before final installation, make sure the monitor will not obstruct the dash, shifter or any other controls.
- Upon installation, do not attempt to move the monitor up/down by hand. Use the **ANGLE ▲/▼** and **OPEN** buttons on the front panel only.
- The unit will stop if it encounters any obstacles during the open/close sequence. If this occurs, remove the obstacle and press **OPEN** again to resume the monitor open/close sequence.

Control Functions - Monitor Closed

BAND	Press BAND to increment from FM1, FM2, FM3, AM1⇒ FM1.
AS/PS (Auto Store /Preset Scan)	Press AS/PS momentarily to start station PRESET SCAN function. Press AS/PS for 2 seconds to start AUTO STORE station preset function in current BAND .
SECONDARY LCD	Additional LCD for system information while monitor is closed.
DISP	Press the DISP button to display various information on the secondary LCD .
OPEN	Press OPEN to open or close the monitor. The unit will emit 1 confirmation beep upon opening, 3 beeps when closing. Be careful not to not touch or obstruct the monitor movement during the open/close sequence, or permanent damage could occur.
EJECT	Press once to eject disc.
ROTARY	Rotate clockwise/counter-clockwise to select desired item and press once to ENTER .
MODE	Press once to incrementally select desired source.
TRACK UP	Selects the next chapter/track for playback.
TRACK DOWN	Selects the previous chapter/track for playback.
STOP	Stop playback of DVD/CD/MP3.
PLAY/PAUSE	Press once for PAUSE , press again for PLAY .
FAST FORWARD	Fast forward the content.
FAST REVERSE	Fast reverse the content.
MUTE	Press once to MUTE audio, MUTE will appear in the secondary LCD . Press again to return audio.
POWER ON/OFF	Press POWER momentarily to turn the unit on, the unit will beep 2 times. Press and hold POWER for more than 2 seconds, unit will beep 1 time, then turn off. Note: EJECT will still function even if POWER is off.
VOLUME	Rotate clockwise/counter clockwise for desired VOLUME level.

Control Locations - Monitor Open



- ① Disc-in indicator - Red = Disc inserted, Blue = No disc.
- ② ANGLE ▼ - Press to decrease the monitor view angle.
- ③ ANGLE ▲ - Press to increase the monitor view angle.
- ④ INFO - Press to select DVD INFO and press and hold for **BRIGHTNESS**.
- ⑤ Press to **RESET** system.

Safety Notes:

The DVD video display of the in-dash unit will not operate while the vehicle is moving. This is a safety feature to prevent driver distraction. In-dash DVD video functions will only operate when vehicle is in Park and the parking brake is engaged. It is illegal in most states for the driver to view video while the vehicle is in motion.

Control Functions - Monitor Open

Disc-in indicator

Blue = No disc
Red = Disc inserted

Monitor Angle ▲▼

Press **ANGLE ▲** to increase the monitor view angle.

Press **ANGLE ▼** to decrease the monitor view angle.

Notes:

- Do not attempt to move the monitor up/down by hand - severe damage will occur. Use the front panel buttons or the remote control only.
- The color of the LCD monitor varies between viewing angles. Select the angle with the most optimum view for your location.
- The last position of the monitor will be saved in memory. The monitor will return to its last position automatically the next time it is opened.

INFO/PIC

Press **INFO** button for 1 second to display DVD disc information.

Press and hold **INFO** for 2 seconds to change TFT LCD **BRIGHTNESS**:

Press **ANGLE ▲** to increase, **ANGLE ▼** to decrease or use **VOLUME** rotary to adjust the level up or down, (0 minimum/20 maximum), 10 is default.

SYSTEM RESET

If you experience abnormal operation or, your unit is inoperable, press the **RESET** button for 3 seconds, located on the front bottom-right corner of the unit. After a system reset, the unit restores all factory default settings.

Note: Use the tip of a pen to access the button.



Control Locations - Remote

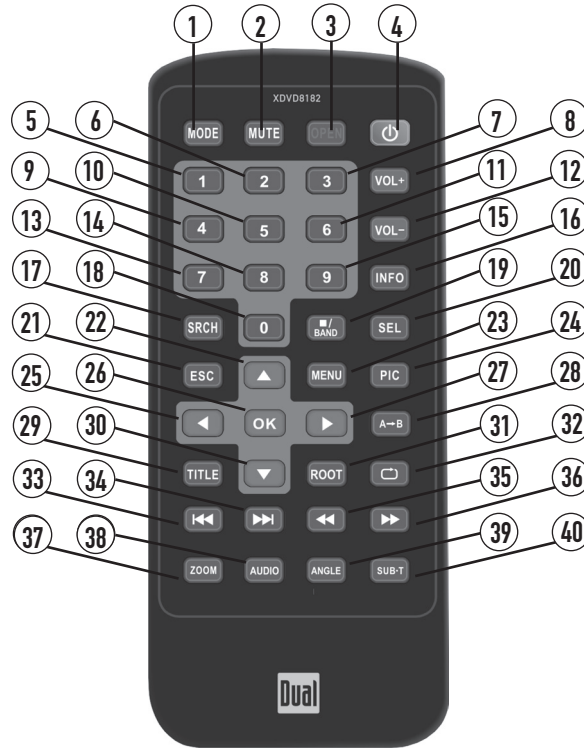

- | | | |
|--------------|---------------|----------------------|
| ① Mode | ⑩ Key #5 | ⑲ Band/Stop |
| ② Mute | ⑪ Key #6 | ⑳ Audio Select |
| ③ Open/Close | ⑫ Volume Down | ㉑ Escape |
| ④ Power | ⑬ Key #7 | ㉒ 4-Way - Up |
| ⑤ Key #1 | ⑭ Key #8 | ㉓ Menu |
| ⑥ Key #2 | ⑮ Key #9 | ㉔ Picture |
| ⑦ Key #3 | | ㉕ 4-Way - Left |
| ⑧ Volume Up | | ㉖ Ok |
| ⑨ Key #4 | | ㉗ 4-Way - Right |
| | | ㉘ Repeat A-B |
| | | ㉙ Title Menu |
| | | ㉚ 4-Way - Down |
| | | ⑳ Info |
| | | ㉛ Search |
| | | ㉜ Key #0 |
| | | ㉝ Audio Select |
| | | ㉞ Escape |
| | | ㉟ 4-Way - Up |
| | | ㊱ Menu |
| | | ㊲ Picture |
| | | ㊳ 4-Way - Left |
| | | ㊴ Ok |
| | | ㊵ 4-Way - Right |
| | | ㊶ Repeat A-B |
| | | ㊷ Title Menu |
| | | ㊸ 4-Way - Down |
| | | ㊹ Root |
| | | ㊺ Repeat |
| | | ㊻ Chapter/Track Down |
| | | ㊼ Chapter/Track Up |
| | | ㊽ Fast Rewind |
| | | ㊾ Fast Forward |
| | | ㊿ Zoom |
| | | ㊿ Audio |
| | | ㊿ Angle |
| | | ㊿ Sub-Title |

* The remote control uses one 3 volt Lithium CR2025 battery. For best performance, replace only with CR2025 or equivalent.

Control Functions - Remote

Mode	Press once to incrementally select desired source
Mute	Press once to MUTE audio, press again to return audio
Open/Close	Press once to open monitor, press again to close the monitor
Power	Press once to turn the unit on, press again to turn unit off
Keys 0-9	Direct access chapter/track/preset station for current BAND
Volume Up	Increase VOLUME
Volume Down	Decrease VOLUME
Info	Displays DVD information
Search	Search function in the DVD/CD disc mode
Band / Stop	Press to increment BAND , or STOP while in DVD/MP3 mode
Audio Select	Enter AUDIO Setup mode
Escape	Exit current menu
4-Way -Up/Down/Left/Right	Navigating system and DVD menus
Menu	Enter the MAIN system menu
Picture	BRIGHTNESS parameter setting for TFT
Ok	Starts/pauses playback or confirm settings
Repeat A-B	Repeat playback from time frame A to time frame B
Title Menu	Enters the title menu on DVD
Root	Enters the main menu of the DVD disc
Repeat	Repeats playback of current DVD chapter
Chapter/Track Down	Selects the previous chapter/track for playback
Chapter/Track Up	Selects the next chapter/track for playback
Fast Rewind	Fast rewinds the disc content
Fast Forward	Fast forwards the disc content
Zoom	Zooming in/out on an image from DVD disc
Audio	Change the audio language for DVD disc playback
Angle	Plays DVD disc in different angle for a scene
Sub-Title	Language selection for subtitle



General Operation

Power On/Off

Press **POWER** momentarily to turn the unit on, the unit will beep 2 times. Press and hold **POWER** for more than 2 seconds, unit will beep 1 time, then turn off. **Note:** **EJECT** will still function even if **POWER** is off.

Monitor Open/Close

Press **OPEN** to open or close the monitor. The unit will emit 1 confirmation beep when opening, 3 beeps when closing. Be careful not to touch the monitor during the open/close sequence.

Notes:

- The unit will stop automatically during open/close if an obstacle is detected. If this occurs, remove the obstacle and press **OPEN** again to resume the monitor open/close sequence.
- Audio can be heard while the monitor is closed.

Monitor Angle Position

Press **ANGLE ▲** to increase the monitor view angle.
Press **ANGLE ▼** to decrease the monitor view angle.

Notes:

- Do not attempt to move the monitor up/down by hand - severe damage will occur. Use the front panel buttons or the remote control only.
- The color of the LCD monitor varies between viewing angles. Select the angle with the most optimum view for your location.
- The last position of the monitor can be saved in memory. The monitor will return to its last position automatically the next time it is opened.

Notes:

- The vehicle must be in park and the parking brake applied to view video on the in-dash monitor.
- As a safety feature, a blue "**CAUTION**" screen will show on the display when the vehicle's parking brake is not engaged. DVD, AV1 audio can be heard while the vehicle is in motion.
- The video display of the in-dash unit will not operate while the vehicle is moving. This is a safety feature to prevent driver distraction. In-dash video functions will only operate when vehicle is in Park and the parking brake is engaged. It is illegal in most states for the driver to view video while the vehicle is in motion. Refer to local laws in your area.

See DVD operation on page 32 for more details on how to initialize the **PARKING BRAKE**.

General Operation

- Mode** Press **MODE** to select between **TUNER**, **DVD**, **AV1**, and **CAMERA** inputs. Modes of operation are indicated in the **OSD** (On Screen Display) and secondary **LCD**.
- Optional Mode Selection** With the monitor open, press the screen to display the **OSD** menu bar and press **TUNER**, **DVD**, **AV1** or **CAMERA** in the **MAIN** menu page to select the desired source.
- Volume** Adjust **VOLUME** using rotary encoder or the **VOL ▲ ▼** buttons (00-40).
- Mute** Press **MUTE** to silence the audio; will appear in the **OSD**. Press **MUTE** again to cancel.
- Audio Adjustment from front panel** Press in **VOLUME** rotary knob on left front panel, Press in **VOLUME** again to advance to desired parameter to be changed, Turn **VOLUME** rotary ⤴ or ⤵ to adjust to desired level, Press in **VOLUME** to advance to next selection, Press and hold the **VOLUME** button on the front panel to exit.

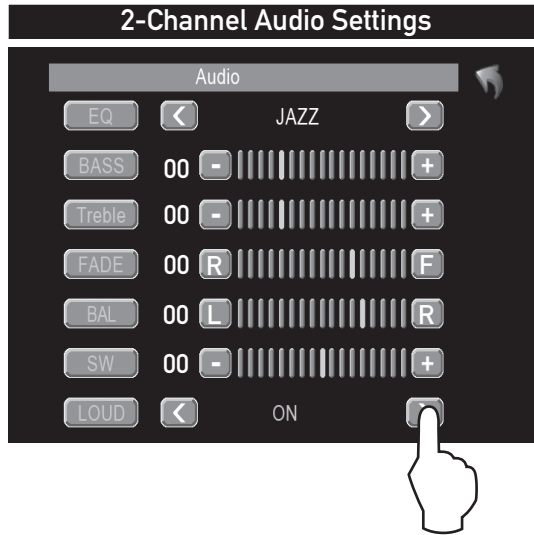

6-Channel Audio Settings	
Item	Adjustable Range
Master Volume	00 to 40
Front Left Channel Volume	-10 to +10
Front Right Channel Volume	-10 to +10
Rear Left Channel Volume	-10 to +10
Rear Right Channel Volume	-10 to +10
Center Channel Volume	-10 to +10
Subwoofer Volume	-10 to +10

Note: 6-Channel audio is only adjustable when "Full 6CH" mode is selected. Refer to page 44 for more details.

- Audio Adjustment from Remote** Press the **SEL** button, Press the **▲ ▼** buttons on the remote to select an item to be adjusted, Press **◀ ▶** to adjust the desired setting, Press the **ESC** button on the remote control to exit the audio control menu.

Notes: The Bass and Treble levels are only adjustable when EQ is set to "User" mode. The Loud function compensates for deficiencies in sound ranges at low levels. When the Loud function is on, LOUD is displayed on the screen.



XDVD8182 OPERATION

General Operation

INFO/PIC

Press **INFO** button for 1 second to display DVD disc information.

RGB BRIGHTNESS

Press and hold **INFO** for 2 seconds to change TFT LCD **BRIGHTNESS**: Press **ANGLE ▲** to increase, **ANGLE ▼** to decrease, or use **VOLUME** rotary to adjust the level up or down. (0 minimum/20 maximum) 10 is default.

CVBS Screen Controls

While in **AUX-IN** or **CAMERA** mode:

Press and hold **INFO** for 2 seconds to access **PICTURE MENU**, press **INFO** briefly again to step to next selection:

- SHARPNESS
- CONTRAST
- COLOR
- BRIGHTNESS
- TINT

Note: Adjustments to **SHARPNESS, CONTRAST, COLOR, BRIGHTNESS & TINT** are only possible while in either **AUX-IN** or **CAMERA CVBS** mode.

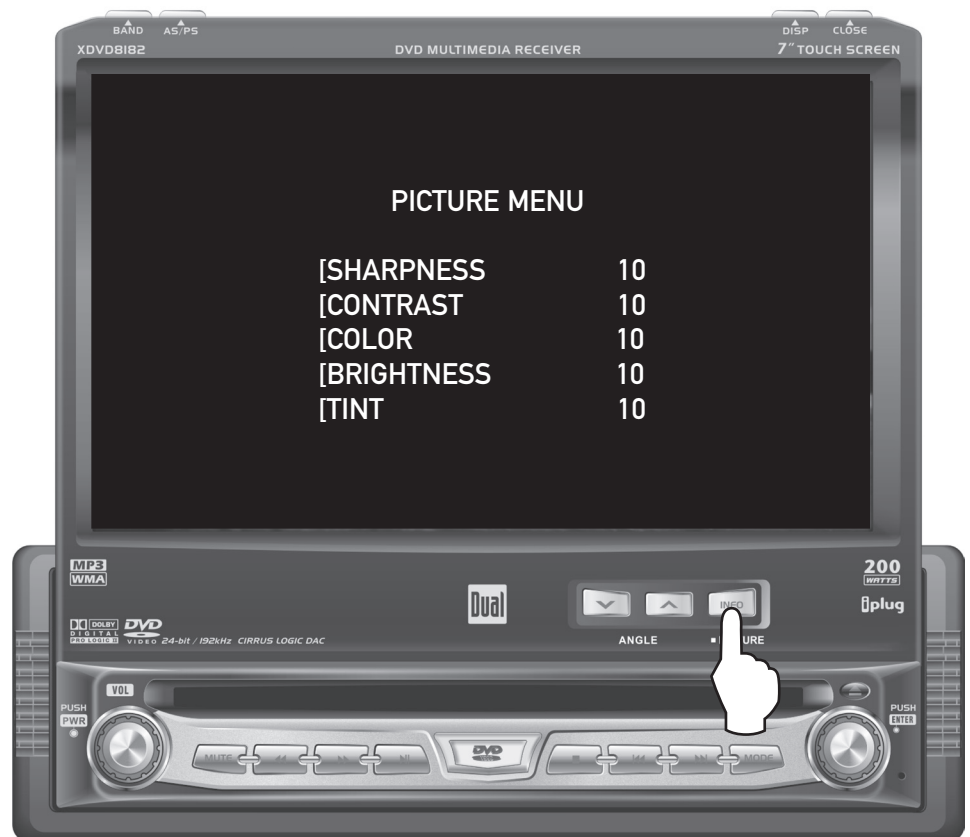

Press ▼ or ▲ to adjust the sharpness (0 minimum/+20 maximum).

Press ▼ or ▲ to adjust the contrast (0 minimum/+20 maximum).

Press ▼ or ▲ to adjust the color (0 minimum/+20 maximum).

Press ▼ or ▲ to adjust the brightness (0 minimum/+20 maximum).

Press ▼ or ▲ to adjust the tint (0 minimum/+20 maximum).

General Operation

BAND	Press BAND to increment from FM1, FM2, FM3, AM1 ⇒ FM1.
AS/PS (Auto Store /Preset Scan)	Press AS/PS momentarily to start station PRESET SCAN function. The unit will now scan your program presets for 10 seconds for each preset in that band. Press AS/PS again to stop scanning. Press AS/PS for 2 seconds to start AUTO STORE station preset function in current BAND .
DISP	Press the DISP button to display various information on the secondary LCD screen when the monitor is closed.
OPEN	Press OPEN to open or close the monitor. The unit will emit 1 confirmation beep upon opening, 3 beeps when closing. Be careful not to not touch or obstruct the monitor movement during the open/close sequence, or permanent damage could occur.
EJECT	Press once for DISC ejection.
ROTARY	Press to access MAIN menu, rotate clockwise/counter-clockwise to select desired item and press once to ENTER .
MODE	Press once to incrementally select desired source.
TRACK UP	Selects the next chapter/track for playback.
TRACK DOWN	Selects the previous chapter/track for playback.
STOP	Stop playback of DVD/CD/MP3 .
PLAY/PAUSE	Press once for PAUSE , press again for PLAY .
FAST FORWARD	Fast forward the disc content.
FAST REVERSE	Fast reverse the disc content.
MUTE	Press once to MUTE audio, press again to return audio, an icon indicator will flash on the TFT monitor.
POWER ON/OFF	Press POWER momentarily to turn the unit on, the unit will beep 2 times. Press and hold POWER for more than 2 seconds, unit will beep 1 time, then turn off. Note: EJECT will still function even if POWER is off.
VOLUME	Rotate VOLUME rotary knob ⤴ or ⤵ for desired VOLUME level, press once to access the AUDIO SETUP MENU .
PROGRAMMABLE TURN-ON VOLUME	Turn VOLUME rotary to desired listening level, press and hold VOLUME rotary knob for 3 seconds to program currently selected volume level.

General Operation



Secondary LCD Information

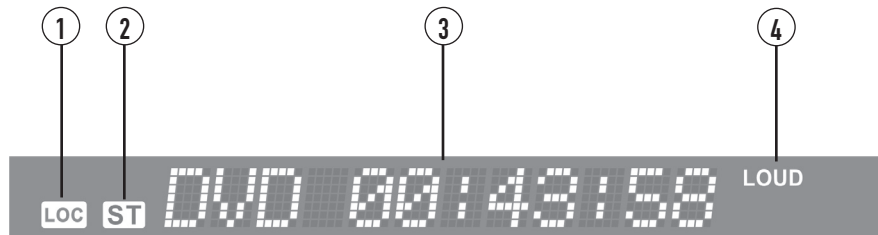

NOTE: Secondary LCD only functions when TFT monitor is closed.

- 1) **LOC** LOCAL indicator, icon will be off when **DISTANCE (DX)** is selected
- 2) **ST** STEREO radio station indicator
- 3) **TIME** Displays **TRACK** time, **TUNING** frequency, **MP3 ID3** info, & **CLOCK**, etc
- 4) **LOUD** LOUDNESS selection indicator

General Operation

Main Menu Access

There are three methods to access the MAIN menu

- Press the ENTER button on the right ROTARY knob
- Press the MENU button on the remote control
- Touch the upper left corner of the touch screen

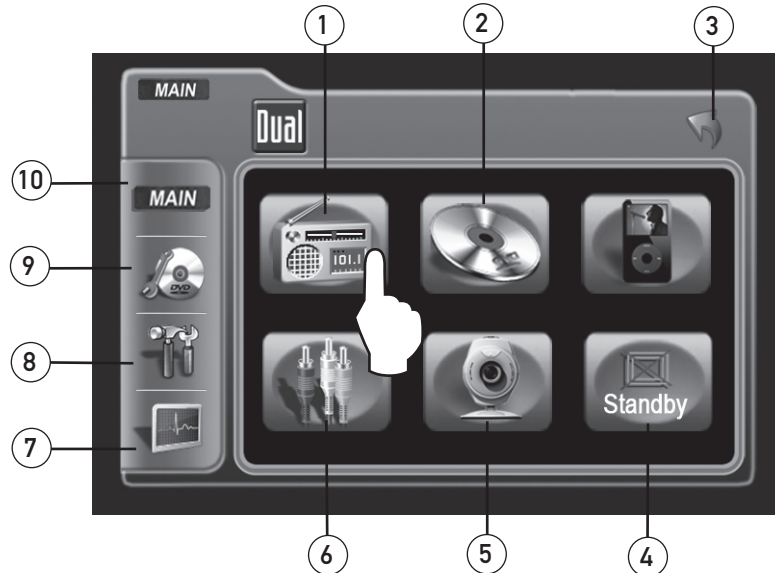

Touch Access Buttons

- 1) Touch to access **AM/FM TUNER** mode
- 2) Touch to access **CD/DVD** mode, **CD/DVD** must be inserted
- 3) Touch to **RETURN** to previous screen
- 4) Touch to **STANDBY** screen, touch screen again or any button to resume display.
Note: **VOLUME** level can be controlled without interrupting **STANDBY**
- 5) Touch to access **CAMERA** mode, if optional camera isn't connected then "No Signal Detected" will be displayed
- 6) Touch to access **AUXILIARY A/V INPUT** mode
- 7) Touch to access **SCREEN SETUP** menu
- 8) Touch to access **GENERAL SETUP** menu
- 9) Touch to access **CD/DVD SETUP** menu, **CD/DVD** must be inserted to function
- 10) Touch to access **MAIN** Source menu

Rapid Dial

RAPID DIAL can also control touch screen functions from the main menu

- Select desired function rotating clockwise or counter-clockwise
- Function will be outlined in yellow
- Press to confirm/ENTER

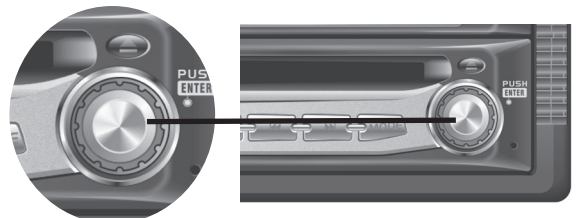

GENERAL Setup - Menu

General Setup Menu



- Press the GENERAL button to access the GENERAL setup mode
- Select desired parameter you wish to change
- Page will return back to previous screen after 10 seconds of inactivity or by pressing the RETURN button

Note:
Default anti-theft password
is 0000

GENERAL Setup Menu matrix

Settings	Default	Options	Function
Radio	USA	USA	Set to appropriate setting for your country
		S-Amer1	
		S-Amer2	
		Europe	
Clock adjust	AM	00:00	See adjusting the clock on page 23 for more details
Clock Mode	12Hr	12Hr	PM 6:00
		24Hr	18:00
Camera Image	Normal	Normal	Normal Image
		Reverse	Mirror camera input image 180 degrees
Video Format	Auto	Auto	System will auto detect NTSC or PAL
		NTSC	For NTSC compatibility
		PAL	For PAL compatibility
TFT Auto Open	Off	On	TFT panel will automatically open when IGN is turned on
		Off	TFT will remain closed until the OPEN button is pressed
		Manual	TFT will only open/close when OPEN button is pressed
Anti-theft Code	0000	----	Must enter password to turn anti-theft on or off
Anti-theft active	Off	On	System will require a password if main battery power is removed for more than 5 minutes
		Off	No password will be required if power is removed
Load Factory defaults	Yes	Are you sure? Yes/Cancel	Load all factory parameters to their original settings. Note: This will not reset the anti-theft password.

Note: Not all GENERAL setup features are described in detail.

GENERAL Setup - Adjusting Radio Frequency

Adjusting Radio Frequency

Step 1

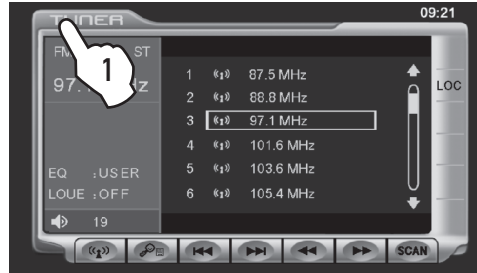

1) Touch top left corner of screen

Step 2

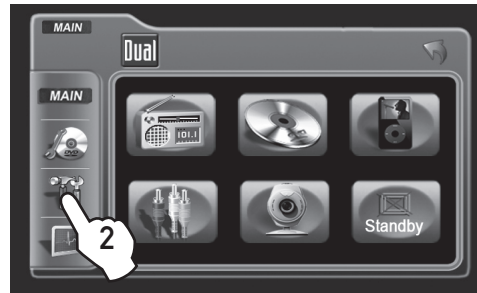

2) Touch GENERAL setup button

Step 3

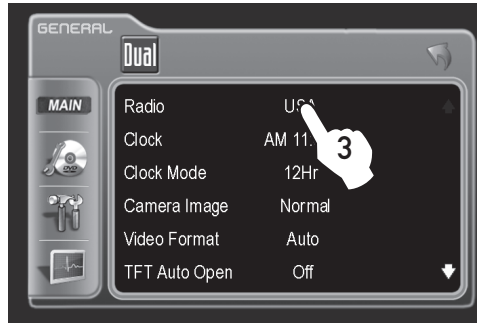

3) Touch USA

Step 4

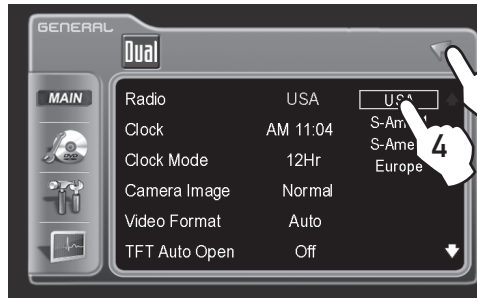

4) Touch the setting for your region

Step 5

Touch RETURN to exit

GENERAL Setup - Adjusting the Clock

12Hr Clock Mode

Step 1

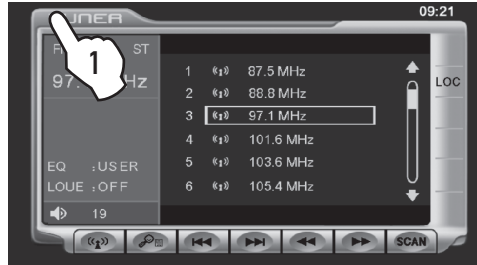

1) Touch top left corner of screen

Step 2

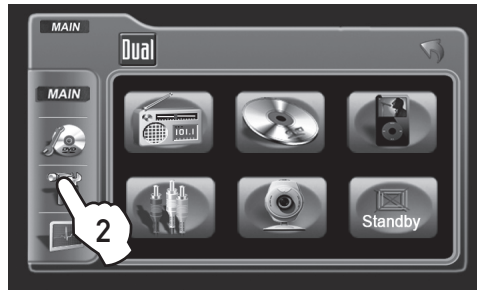

2) Touch GENERAL setup button

Step 3

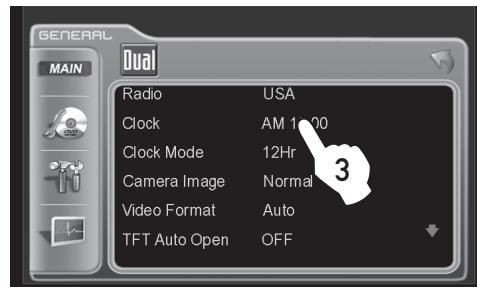

3) Touch 00:00 area in the CLOCK row

Steps 4-8



4) Keypad should now appear

5) Enter HOURS, touch ok

6) Enter MINUTES, touch ok

7) Touch AM or PM to set

8) Touch RETURN to exit

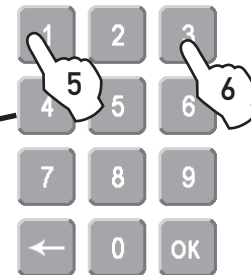

24Hr Clock Mode

If you desire 24Hr format, select 24Hr from CLOCK MODE, then follow steps 1-8.

GENERAL Setup - Setting the Anti-theft code

By default Anti-theft password is 0000 and is turned Off. To turn this feature on, follow the steps below.
CAUTION!!
 This will lock your unit from operating if battery POWER is disconnected for more than 5 minutes.

Step 1 & 2

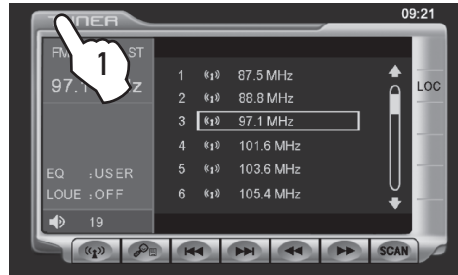

1) Touch top left corner of screen

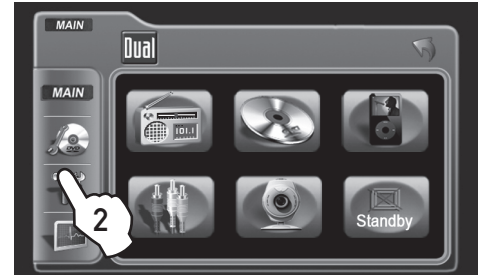

2) Touch GENERAL Setup button

Step 3 & 4

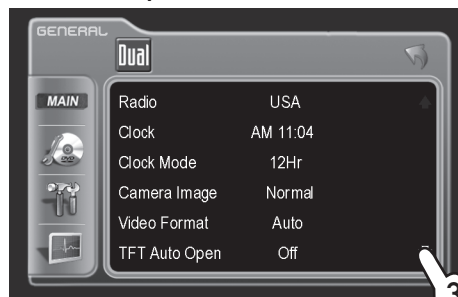

3) Touch down arrow button

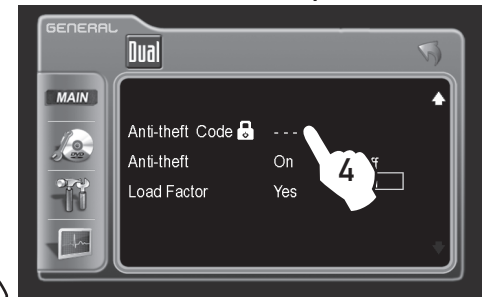

4) Touch ----

Step 5 & 6

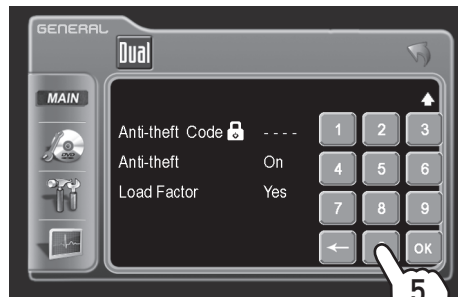

5) Enter 0000, then press ok

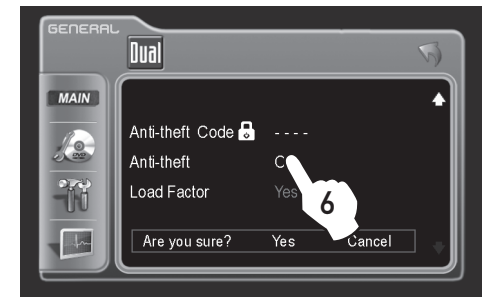

6) Touch OFF

Step 7 & 8

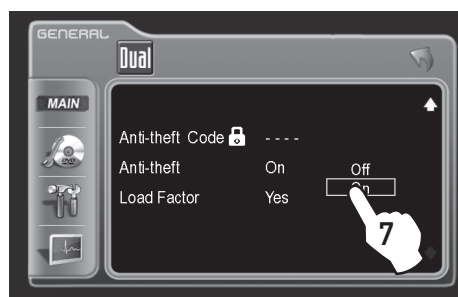

7) Touch ON

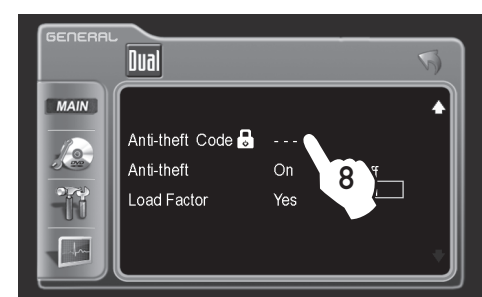

8) Touch ---- again

Step 9 & 10

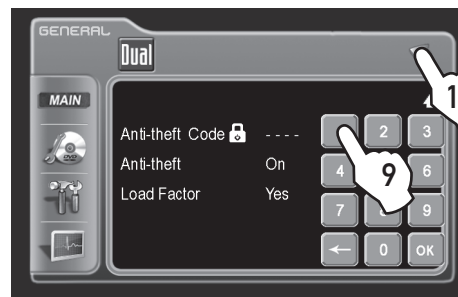

9) Enter your new 4-digit password, then press ok.

10) Touch RETURN to exit

Note: it is recommended that you choose your own 4-digit password carefully, write it down somewhere and keep in a safe location. In the event you ever loose or forget your password, call our tech hot line for support on how to unlock your system.

SCREEN Setup - Menu

Screen Setup Menu



- Press the SCREEN button to access the SCREEN setup mode
- Select desired parameter you wish to change
- Page will return back to previous screen after 10 seconds of inactivity or by pressing the RETURN button

SCREEN Setup Menu matrix

Settings	Default	Options	Function
Brightness	10	0 - 20	Press the ◀ or ▶ buttons on the remote or press the right rotary once and rotate clockwise/counter-clockwise to adjust the BRIGHTNESS to the desired setting
Screen Tilt	4	1 - 6	Select 1 to 6 to adjust the default tilt angle of the screen
Screen Saver	On	Off	Select On to activate the screen saver, Off to deactivate
		On	
TS Calibrate	No	No	Touch Yes to enter the Touch Screen calibration mode
		Yes	
Version			Software version of unit

System Standby



To conserve the LCD backlight lifespan or to eliminate glare while night driving, press STANDBY. The TFT screen will black out, however all other operations continue to operate. Press any button except **VOLUME** or touch the screen again to return to normal viewing.

SCREEN Setup - Setting TFT Brightness

This will set the default setting for the TFT display brightness.
 This can also be set by pressing the INFO button on the front TFT panel.

Step 1

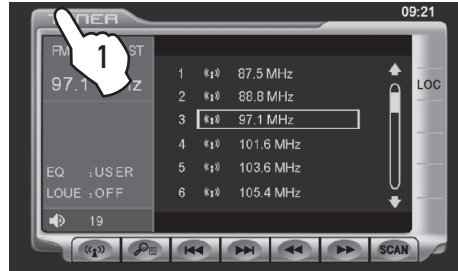

1) Touch top left corner of screen

Step 2

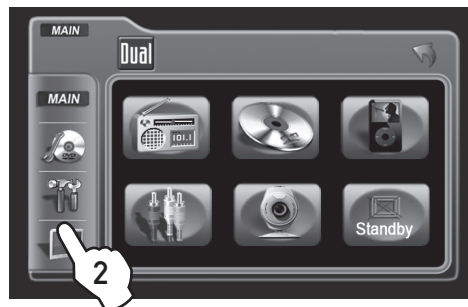

2) Touch SCREEN setup button

Step 3

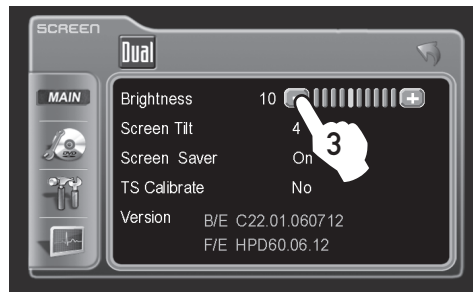

3) Touch [-] to dim TFT

Step 4



4) Touch [+] to brighten TFT

0 - 20 is possible
 Default = 10

Step 5

5) Touch RETURN to exit

SCREEN Setup - Setting TFT Angle

Set for best viewing angle for your vehicle

Step 1

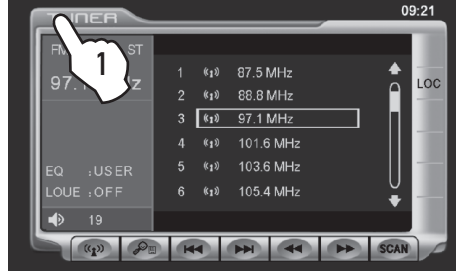

1) Touch top left corner of screen

Step 2

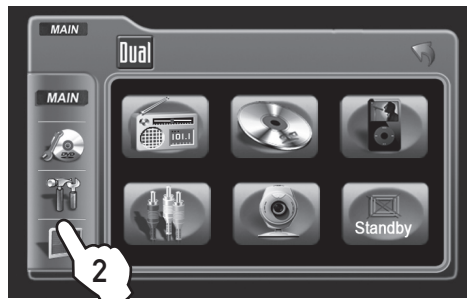

2) Touch SCREEN setup button

Step 3

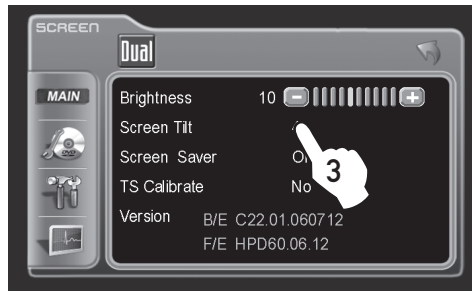

3) Touch a number displayed in SCREEN TILT row

Step 4



4) Touch desired angle for best viewing angle

1 - 6 is possible

Default = 4

Step 5

5) Touch RETURN to exit

SCREEN Setup - Touch Screen Calibration

On occasion, the touch screen will have to be calibrated. Follow these steps as described.

Step 1

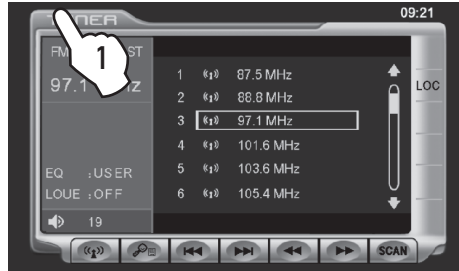

1) Touch top left corner of screen

Step 2

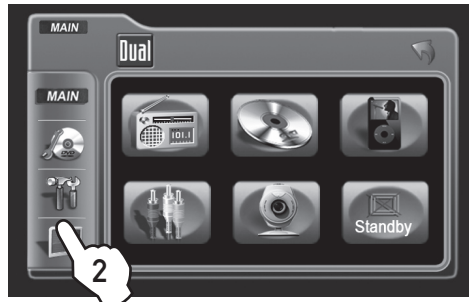

2) Touch SCREEN setup button

Step 3 & 4

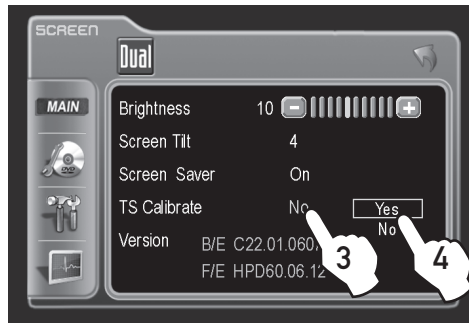

3) Touch No in TS Calibration row
4) Then touch Yes

Step 5 & 6

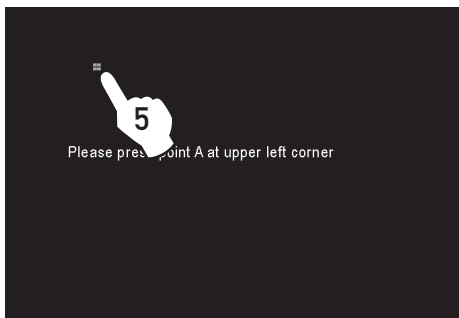

5) Touch and hold the pointers as indicated on the screen for 2 seconds each
6) Screen will automatically return to MAIN MENU, touch RETURN to exit

Note: For proper calibration you must touch each pointer for 2 seconds. If pointers are not touched properly, the calibration sequence will start over until the calibration is done correctly.

AM/FM Tuner Operation

AM/FM Tuner TFT Display

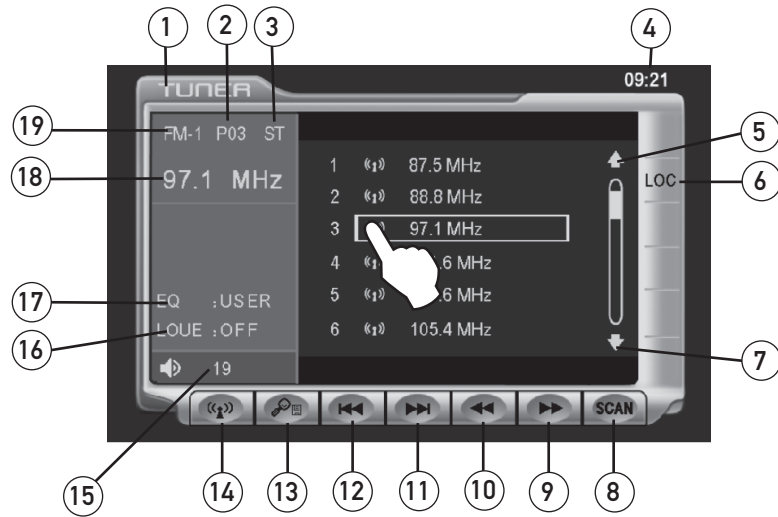

- 1) Current **MODE** information, touch upper left area to return to **MAIN MENU**
- 2) Current **PRESET** station indicator
- 3) **STEREO** broadcast indicator
- 4) **Clock**
- 5) **PRESET** page up
- 6) **LOCAL/DISTANCE** selection
- 7) **PRESET** page down
- 8) Auto station **SCAN** button
- 9) **MANUAL TUNE** up
- 10) **MANUAL TUNE** down
- 11) **SEEK TUNE** up
- 12) **SEEK TUNE** down
- 13) **AS/PS (AUTO STORE/PRESET SCAN)**
- 14) **BAND** selection, FM1, FM2, FM3, AM
- 15) **VOLUME** indicator
- 16) **LOUD** indicator
- 17) Equalizer indicator, touch to access **AUDIO** Setup menu
- 18) Current radio frequency indicator
- 19) Current radio **BAND** indicator

AM/ FM Tuner Operation

- Auto Seek Tuning**

Press the button to auto **SEEK** up the next strongest station.

Press the button to auto **SEEK** down the next strongest station.
- Manual Tuning**

Press the button to manually tune up one step at a time.

Press the button to manually tune down one step at a time.
- Auto Store (AS)**

Press and hold **AS/PS** for more than 2 seconds to automatically store the twelve strongest stations in the current band. Automatic Local tuning is activated during the initial band scan, repeat for other bands.

NOTE: All presets within the current band will be overwritten.
- Program Scan (PS)**

Press **AS/PS** for less than 2 seconds to scan presets 1-12 on the current band, pausing for 10 seconds at each. Press **AS/PS** again to cancel.
- SCAN**

Press **SCAN** to preview strong stations on the current band, pausing for 10 seconds at each station. Press **SCAN** again to cancel.
- LOC/DX Radio Station**

Touch **LOC** button on the TFT to activate **LOC/DX** tuning. When the **LOCAL** function is on, **LOC** will appear. Only radio stations with a strong signal are received. **DISTANCE (DX)** is for radio stations that are far away and/or have weak signals.
- Storing Radio Stations PRESET**

Up to 36 FM stations and 12 AM stations can be stored. To store a station, select the desired band and station. Press and hold the desired preset button (1-12) for more than 2 seconds. When stored, the **PRESET** number will appear in the display. The station can be recalled anytime by pressing the corresponding preset button on the TFT.
- Recalling a Radio Station PRESET**

Touch a corresponding radio frequency for less than 2 seconds to recall.
- PRESET Page Up/Down**

Only 6 PRESETS can be display at one time, use PRESET page up/down to access next stored PRESETS accordingly.

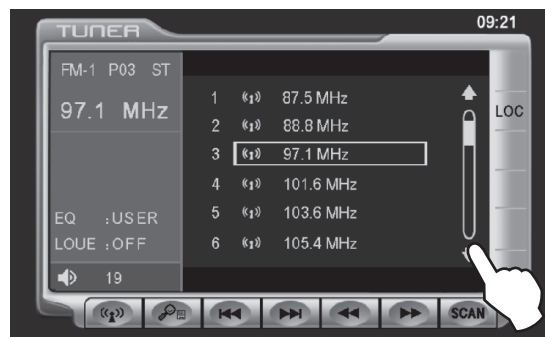



XDVD8182 OPERATION

⚠ WARNING ⚠

Upon installation of this Monitor/DVD player (“unit”) into a vehicle, the driver of the vehicle must not operate this unit by watching videos or playing video games while driving. Failure to follow this instruction could lead to driver distraction which could result in serious injury or death to the vehicle’s occupants or persons outside the vehicle and/or property damage.

Several states prohibit the installation of monitors/DVD players if the screen is visible from the driver’s seat. If you reside in a jurisdiction which has enacted such a law, this unit must not be installed so that the screen is visible from the driver’s seat. When installing this unit in the front console/dashboard, the unit must be positioned so that it is facing the front passenger seat only. Failure to follow this instruction could lead to driver distraction which could result in serious injury or death to the vehicle’s occupants or persons outside the vehicle and/or property damage.

This unit is designed so that it may be operated only when the vehicle is in “Park” and the parking brake is fully engaged. To this end, this unit includes a parking brake lock-out feature which prohibits the unit from operating if the vehicle is not in “Park” and/or the parking brake is not fully engaged. When installing this unit, the installer must connect the parking brake detect wire (“Yellow-Blue Lead”) to the parking brake mechanism in order to make the parking brake lock-out feature operable. **DO NOT** simply ground the parking brake detect wire to a metal portion of the vehicle. Failure to properly install the parking brake lock-out feature could lead to driver distraction which could result in serious injury or death to the driver’s occupants or persons outside the vehicle and/or property damage.

Once the parking brake lock-out feature is installed, the owner/user must not attempt to disrupt/neutralize the parking brake lock-out feature by (a) partially engaging the parking brake and/or (b) purchasing/using any device or unit designed to send necessary brake signals to the unit. Failure to follow these instructions could lead to driver distraction which could result in serious injury or death to the driver’s occupants or persons outside the vehicle and/or property damage.

When operating this unit, keep the unit’s volume level low enough so that the vehicle’s occupants can hear traffic-related sounds such as police and emergency vehicles. Failure to follow this instruction could lead to driver distraction which could result in serious injury or death to the vehicle’s occupants or persons outside the vehicle and/or property damage.

DVD Operation - Parking Brake Initialization



CAUTION !!!
 IT'S UNLAWFUL TO OPERATE
 A VEHICLE WHILE VIDEO IS
 DISPLAY IN THE DRIVERS
 VIEWING AREA

ENGAGE EMERGENCY BRAKE
 TO ENJOY VIDEO

SAFETY WARNING 

- The video display of the in-dash unit will not operate while the vehicle is moving. This is a safety feature to prevent driver distraction. In-dash video functions will only operate when vehicle is in Park and the **PARKING BRAKE** is engaged. It is illegal in most states for the driver to view video while the vehicle is in motion. Refer to local laws in your area.
- Audio can be heard while the monitor is closed.
- The vehicle must be in park and the parking brake applied to view video on the in-dash monitor.
- As a safety feature, "ENGAGE PARKING BRAKE" blue screen will show on the display when the vehicle's parking brake is not engaged. Video display on the front monitor isn't allowed until the **PARKING BRAKE** is engaged. By connecting the yellow/blue **PARKING BRAKE** wire to brake switch circuit as described below, DVD and AV1 audio can be heard while the vehicle is in motion without engaging the parking brake.

Front TFT Video Initialization

Follow these two initialization procedures carefully to allow video playback on XDVD8182 front panel TFT:

There are two situations that start the PARKING BRAKE sequence.

**Parking Brake Initialization
 Situation 1**

First situation is while driving:

- 1) Stop vehicle, put in Park, make sure PARKING BRAKE is off/released
- 2) Depress PARKING BRAKE for 1 second
- 3) Release PARKING BRAKE for 1 second
- 4) Depress PARKING BRAKE permanently

Note:

Once above procedure 1-4 is completed, video will display in approx. 6 seconds.

**Parking Brake Initialization
 Situation 2**

Second situation is while already parked and the PARKING BRAKE is already applied:

- 1) Keep vehicle in Park, PARKING BRAKE should be on
- 2) Release PARKING BRAKE for 1 second
- 3) Depress PARKING BRAKE for 1 second
- 4) Release PARKING BRAKE for 1 second
- 5) Depress PARKING BRAKE permanently

Notes:

Once 2nd procedure 1-5 is completed, video will display in approx. 6 seconds. The transition time must be less than 2 seconds between depress and release. This procedure will have to repeated if the IGN is turned off.

DVD Operation

DVD Region Management

Some DVD discs can be played only in certain playback modes according to the intentions of the software. As the XDVD8182 plays discs according to their intentions, some functions may not work as intended. Please be sure to read the instructions provided with each disc. This player has been designed to play back DVD software that has been encoded for specific region areas. It cannot play back DVD software encoded for other region areas than the region areas for which it has been designed.

The XDVD8182 will play discs labeled "Region 1" or "All".

DVD region codes:

- 1 - USA, Canada
- 2 - Japan, Europe, South Africa, Middle East
- 3 - Rep. of Korea, Taiwan, Hong Kong, Parts of Southeast Asia
- 4 - Australia, New Zealand, Mexico, South America
- 5 - Eastern Europe, Russia, India, Africa
- 6 - China



DVD Disc Symbols

Symbol	12cm Disc Properties	Max Play Time
	Single side single layer (DVD-5) Single side double layer (DVD-9) Double side single layer (DVD-10) Double side double layer (DVD-18)	(MPEG 2 Method) 133 minutes 242 minutes 266 minutes 484 minutes
	Single side single layer (VCD)	(MPEG 1 Method) 74 minutes
	Single side single layer	74 minutes

Symbol	Meaning
	Number of voice languages recorded. The number inside the icon indicates the number languages on the disc (maximum of 8).
	Number of subtitle languages available on the disc (maximum of 32).
	Number of angles provided (maximum of 9).
	Aspect ratios available. "LB" stands for Letter Box and "PS" stands for Pan/Scan. In the example on the left, the 16:9 video can be converted to Letter Box video.
	Indicates the region code where the disc can be played. <ul style="list-style-type: none"> · Region 1: USA, Canada, East Pacific Ocean Islands · Region 2: Japan, Western Europe, Northern Europe, Egypt, South Africa, Middle East · Region 3: Taiwan, Hong Kong, South Korea, Thailand, Indonesia, South-East Asia · Region 4: Australia, New Zealand, Middle and South America, South Pacific Ocean Islands/ Oceania · Region 5: Russia, Mongolia, India, Middle Asia, Eastern Europe, North Korea, North Africa, North-West Asia

Notes:

Some DVD discs can be played only in certain playback modes according to the intentions of the software.

As the XDVD8182 plays discs according to their intentions, some functions may not work as intended. Please be sure to read the instructions provided with each disc.

DVD Operation - Inserting a Disc

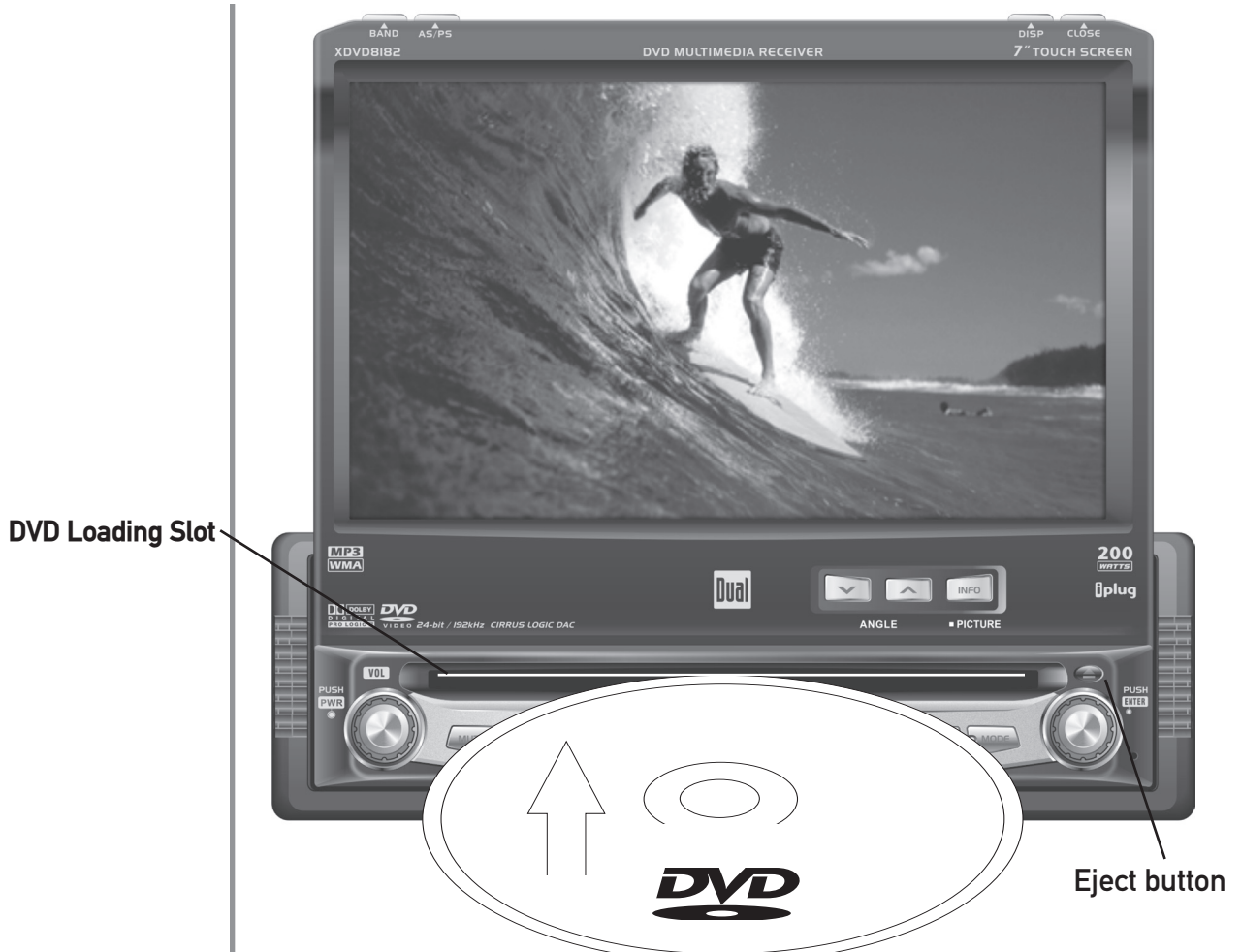

Insert CD/DVD with label facing upwards

Inserting a Disc

When inserting a DVD disc, usually it will play automatically. Other sub-menus may have to be pressed to access the DVD movie/music content. Read the directions of your specific DVD disc for other features.

Note: If PARENTAL Lock is activated and the disc inserted is not authorized, a 4-digit code must be entered and/or the disc be authorized. See "RATING MENU" on page 48.

Note: Only one disc can be inserted at a time.

Ejecting the Disc

Press the EJECT button.

Resetting the Loading Mechanism

If the disc loads abnormally or an system error occurs, press and hold the eject button for 3 seconds to reset the loading mechanism. The disc will eject and normal operation should resume.

DVD Operation - Touch Screen Controls

Hidden Touch Screen area while in TUNER mode

There are several hidden TOUCH SCREEN areas outlined below:

"A" area can be used in any mode to access MAIN menu

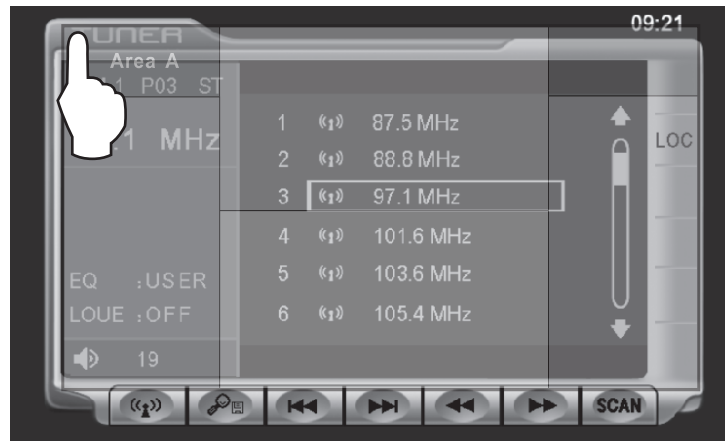

Hidden Touch Screen areas while in DVD mode

"A-F" areas can be used in DVD mode to access:

- A - Displays **MAIN** menu
- B - Displays **DVD** track information
- C - Selects **PREVIOUS** chapter
- D - Selects **NEXT** chapter
- E - Displays the full **DVD** transport controls
- F - **GOTO** search menu



DVD Operation - Touch Screen Controls

Using the hidden Touch Screen Controls

- A - Displays **MAIN** menu
- B - Displays **DVD** track information
- C - Selects **PREVIOUS** chapter
- D - Select **NEXT** chapter
- E - Displays the full **DVD** transport controls
- F - **GOTO** search menu

NOTE:
A DVD disc must be inserted to access these functions and features.

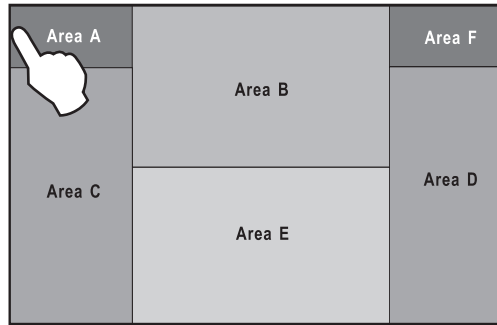

AREA A
Access MAIN Menu

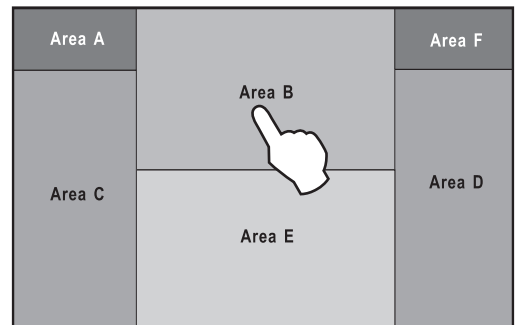

AREA B
Displays Track Information

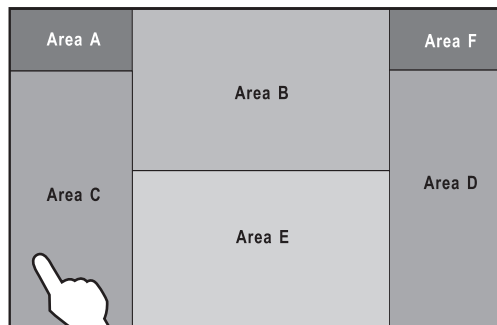

AREA C
Selects PREVIOUS Track

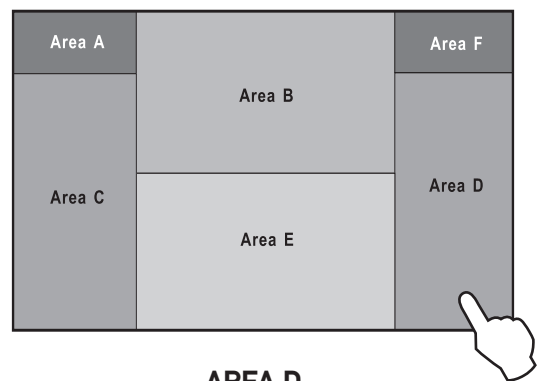

AREA D
Selects NEXT Track

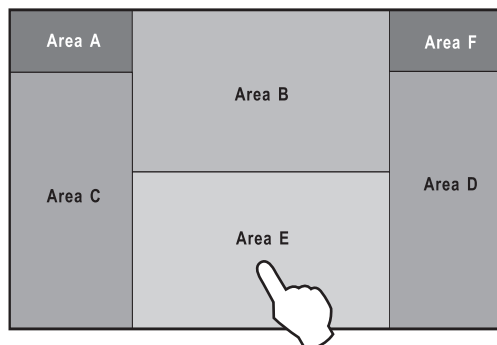

AREA E
Full DVD Transport Controls

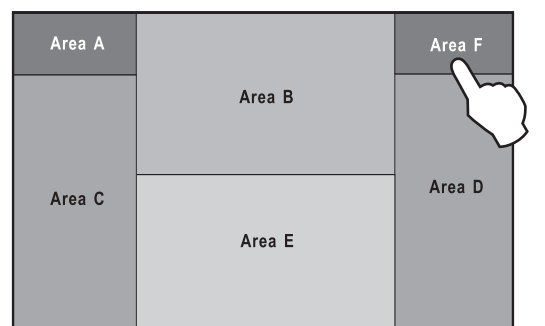

AREA F
DVD Search

DVD Operation - Touch Screen Controls

Using the hidden Touch Screen Controls

Touch AREA E

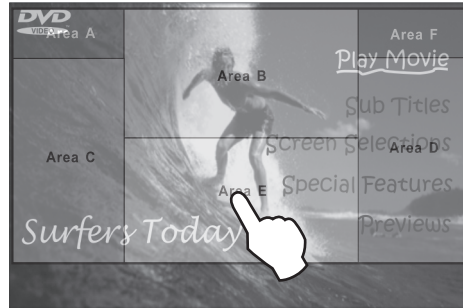

DVD Transport Control OSD

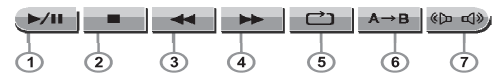

- 1) Touch the **PLAY** button or on the front panel to resume disc playback
- 2) Touch the **PAUSE** button again to suspend the disc playback
- 3) Touch button to **STOP** playback, touch or ok on the remote to resume playback
- 4) Touch the **REVERSE** button to FAST REVERSE on DVD, 2x, 4x, 8x to 20x
- 5) Touch the **FORWARD** button to FAST FORWARD on DVD, 2x, 4x, 8x to 20x
- 6) Touch the **REPEAT** to scroll through the following:
 - DVD: Repeat Title, Repeat Chapter, Repeat Off
 - A) Use the A-B function to define a specific area of disc to repeat.
Press the Repeat A-B button to set a start point of the (A) selection.
 - B) Press the A-B button again once you reach the desired end point (B) of the repeated section. The selected portion of the DVD will now repeat continuously.
 - C) Press A-B button once again to cancel the A-B selection and stop repeat playback.
- 7) Touch to change Audio language playback
- 8) Touch to change Subtitle of DVD
- 9) Touch to return to DVD MAIN menu

DVD Operation - Searching a DVD

Searching a DVD

Searching by Time, Title or Chapter

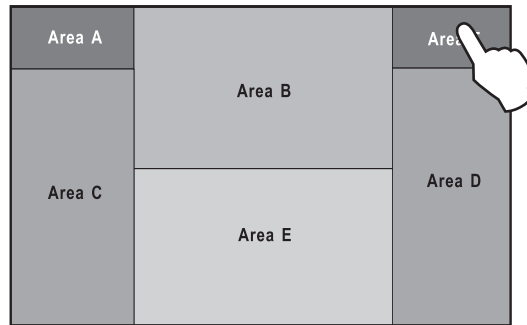

Touch the top right screen - AREA F

Search by TIME example

- 1) Touch the in the TIME area
- 2) A touch keypad will now appear, enter your desired TIME to search
- 3) Press ok

Search	
Time	<input type="text" value="-- : -- : --"/>
Title/Chapter	--- / ---



Notes:

Some DVD discs can be played only in certain playback modes according to the intentions of the software. As the XDVD8182 plays discs according to their intentions, some functions may not work as intended. Please be sure to read the instructions provided with each disc.

DVD Operation

Direct Chapter / Track Selection

During DVD and CD playback, you can use the numeric keypad on the remote control to access tracks directly.

Viewing an Alternate picture Angle (DVD only)

Some DVD's contain scenes that have been shot simultaneously from different angles. For discs recorded with multiple angles, press the ANGLE button on the remote control to toggle between available angles.

Multi-Language Disc

If you are watching a disc recorded in multiple languages, press the AUDIO button on the remote control to choose your desired language. You can also touch AREA E and use the  button to change languages.

Changing Subtitle Language

If you are watching a disc recorded in multiple languages with subtitles, press the SUB-T button on the remote control to choose your desired subtitle. You can also touch AREA E and use the  button to change subtitles.

DVD Playback Information

During playback, press the INFO button on the remote control or touch AREA B to display the DVD playback information on screen.

The following information will be displayed:

Playback Information

	②		⑤	⑦
①	③	④	⑥	
DVD VIDEO	T:4/16 C:1/20	00:01:35	USER ON	08:06

- 1) Indicates current source playing
- 2) Indicates the fourth of sixteen titles on the DVD is currently playing
- 3) Indicates the first of twenty chapters on the DVD is currently playing
- 4) Indicates the playback time of the current title
- 5) Indicates the USER defined EQ levels
- 6) Indicates the LOUD setting is on
- 7) Indicates the current time

DVD Setup Menu - Language

LANGUAGE Setup Menu

Note:
A DVD disc must be inserted to access these functions and features.

With the monitor open in DVD mode, press the AREA A (top left screen) to display the MAIN menu. Press **DVD Setup** to access the DVD setup menu.

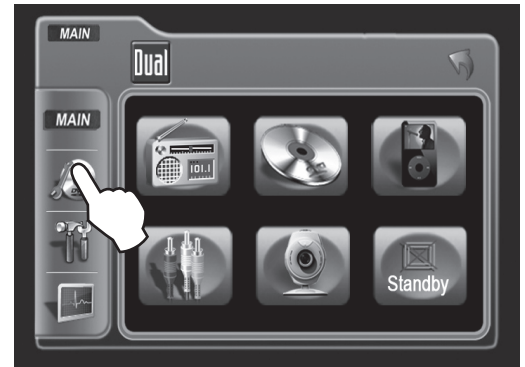

Press **LANGUAGE** icon to select **LANGUAGE** setup page

Disc Subtitle

Press to select desired disc subtitle language

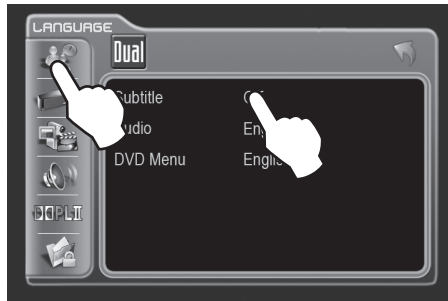

- English
- French
- Spanish
- Auto
- Off = DEFAULT

Audio Language

Press to select desired disc audio language

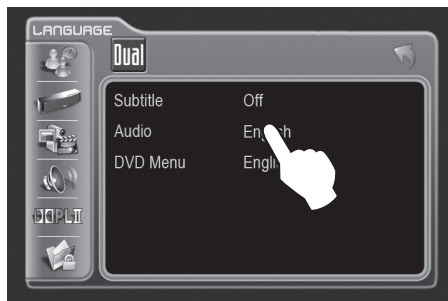

- English = DEFAULT
- French
- Spanish

DVD Menu

Press to select desired disc menu language

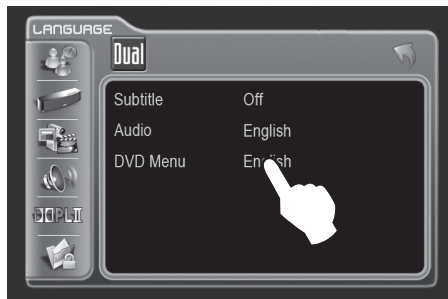

- English = DEFAULT
- French
- Spanish

DVD Setup Menu - Audio

Audio Setup Menu

Note:

A DVD disc must be inserted to access these functions and features.

With the monitor open in DVD mode, press the AREA A (top left screen) to display the MAIN menu. Press **DVD Setup** to access the DVD setup menu.

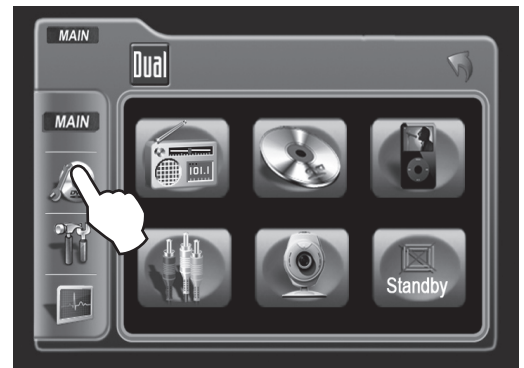

Press **AUDIO** icon to select from the following menus:

Pink Noise

Press to activate pink noise generator for the desired channel. The pink noise generator is used to set the relative speaker levels for multi-channel playback.

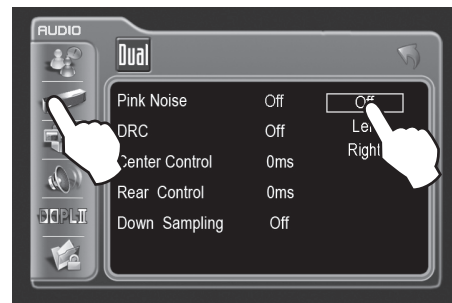

Downmix (2-channel) Settings

Off = DEFAULT

Left

Right

Dynamic Range Control

Select On to activate dynamic range control.

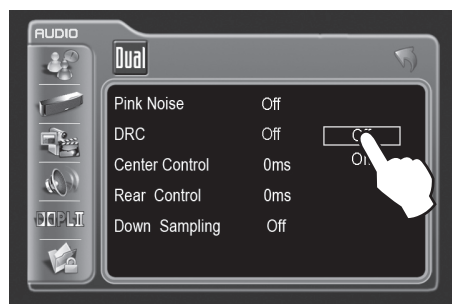

Off = DEFAULT

On

DVD Setup Menu - Audio

Center Control

Press to select desired center channel time delay. The distance is defined in milliseconds.

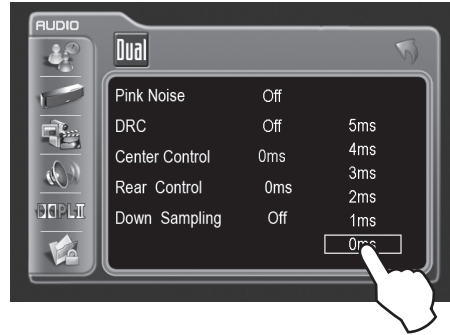

- 5ms
- 4ms
- 3ms
- 2ms
- 1ms
- 0ms = DEFAULT

Rear Control

Press to select desired rear channel time delay. The distance is defined in milliseconds.

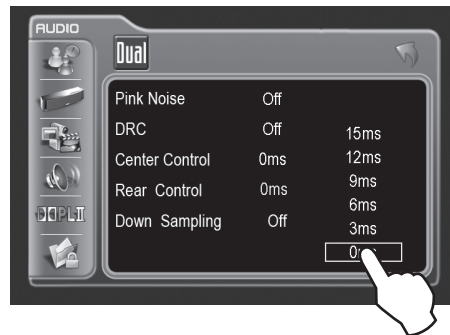

- 15ms
- 12ms
- 9ms
- 6ms
- 3ms
- 0ms = DEFAULT

Down Sampling

Select On to activate audio down sampling. The DVD audio output will be downsampled to 48kHz. The original sampling frequency is preserved when Off is selected.

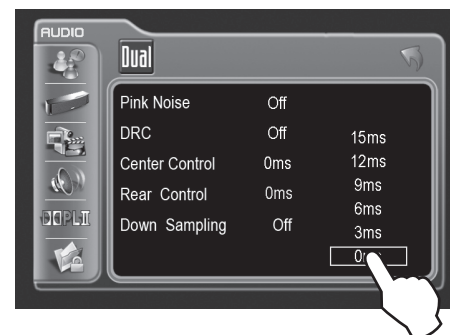

- Off = DEFAULT
- On

DVD Setup Menu - Video

Video Setup Menu

Note:

A DVD disc must be inserted to access these functions and features.

With the monitor open in DVD mode, press the AREA A (top left screen) to display the MAIN menu. Press **DVD Setup** to access the DVD setup menu.

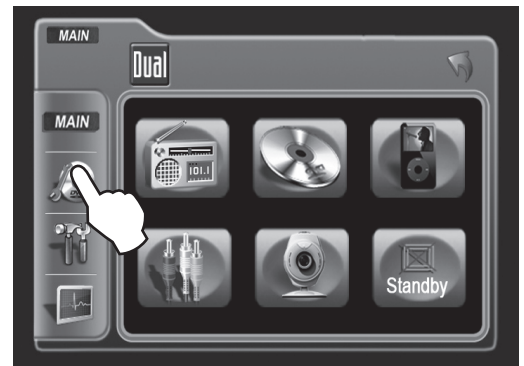

Press **VIDEO** icon to select from the following menus:

TV Shape

Press to select desired TV shape

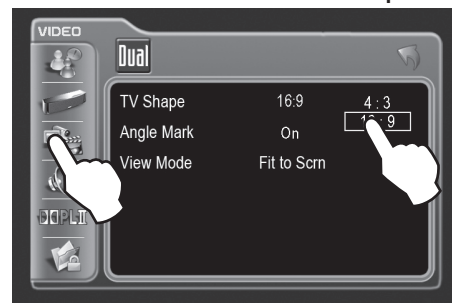

4:3
16:9 = DEFAULT

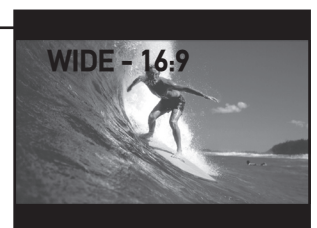
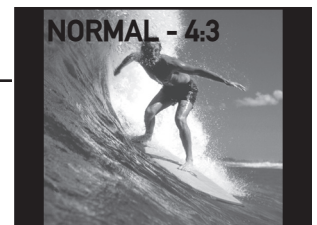

Angle Mark

Select On to activate angle mark



On = DEFAULT
Off

View Mode

Press to select desired view mode

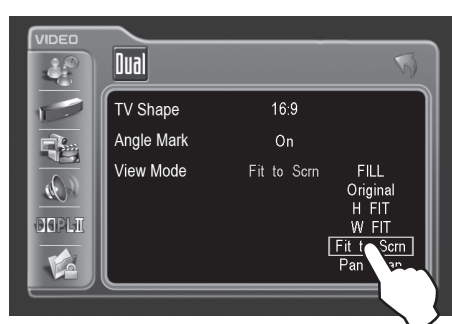

FILL
Original
H FIT
W FIT
FIT to Screen = DEFAULT
Pan Scan

DVD Setup Menu - Speaker

Speaker Setup Menu

Note:
A DVD disc must be inserted to access these functions and features.

With the monitor open in DVD mode, press the AREA A (top left screen) to display the MAIN menu. Press **DVD Setup** to access the DVD setup menu.

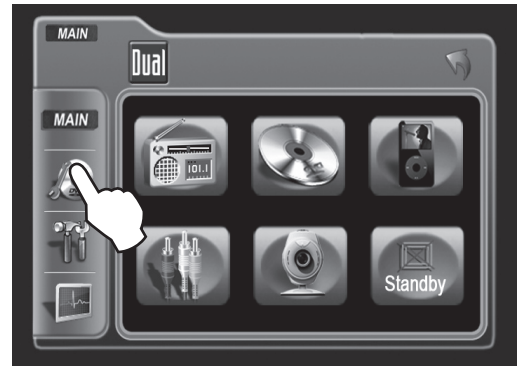

Press **SPEAKER** icon to select from the following menus:

Speaker Mode

Select desired speaker output mode

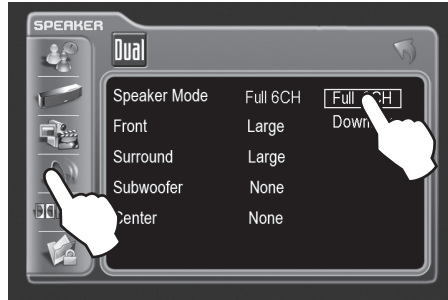

Full 6CH
DownMix = DEFAULT

*Front Speaker Size

Select size of front speaker

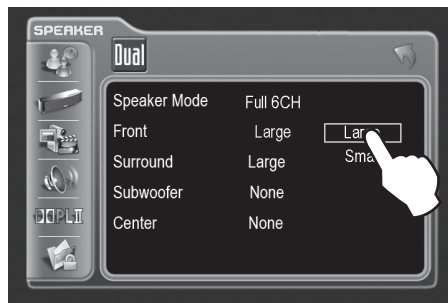

Large = DEFAULT
Small

Note: *Full 6CH mode must be selected to adjust the front speaker size.

DVD Setup Menu - Speaker

*Surround Speaker Size

Note:
A DVD disc must be inserted to access these functions and features.

Select size of surround speaker

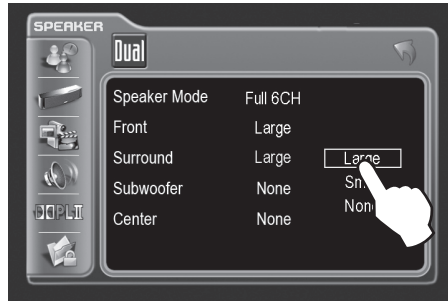

Large = DEFAULT
Small
None

*Subwoofer Speaker

Select Present if a subwoofer is included in your system

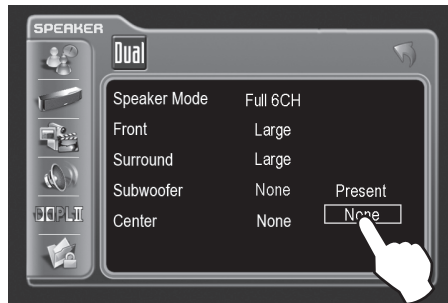

Present
None = DEFAULT

*Center Speaker Size

Press to select size of center speaker

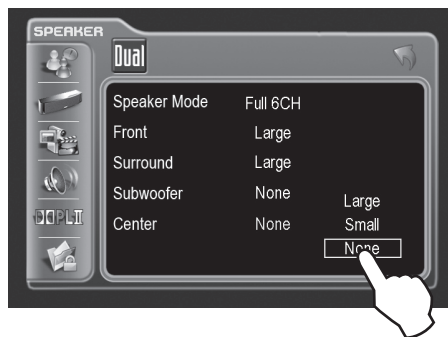

Large
Small
None = DEFAULT

Note: *Full 6CH mode must be selected to adjust the surround speaker size, subwoofer speaker and center speaker size.

DVD Setup Menu - Pro Logic II

Pro Logic II Setup Menu

Note:
A DVD disc must be inserted to access these functions and features.

With the monitor open in DVD mode, press the AREA A (top left screen) to display the MAIN menu. Press **DVD Setup** to access the DVD setup menu.

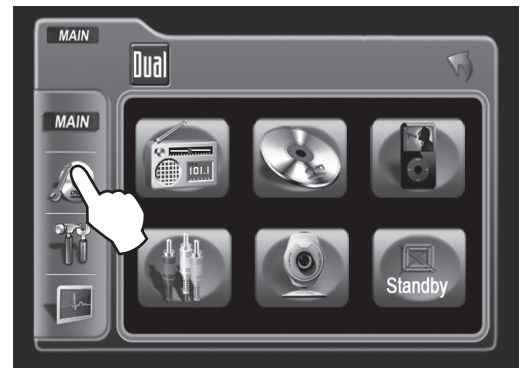

Press Pro Logic II icon to select from the following menus:

Decode Mode

Select desired decode mode

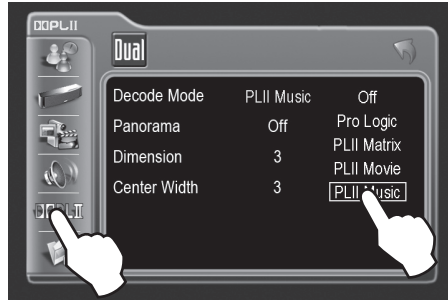

- Off
- Pro Logic
- PLII Matrix
- PLII Movie
- PLII Music = DEFAULT

*Panorama

Select On to activate panorama mode

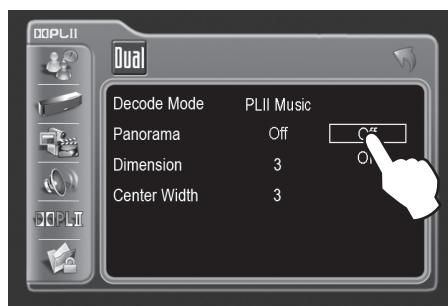

- Off = DEFAULT
- On

Activating panorama mode extends the front stereo image to include the surround speakers for a wraparound effect.

Note: *PLII Music decode mode must be selected to activate panorama mode.

DVD Setup Menu - Pro Logic II

***Dimension** | Select desired dimension

Note:
A DVD disc must be inserted to access these functions and features.

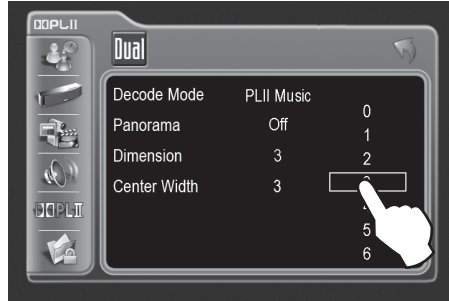

- 0
- 1
- 2
- 3 = DEFAULT
- 4
- 5
- 6

Changing the dimension control allows you to adjust the soundstage either towards the front or towards the rear.

***Center Width** | Select desired center channel width

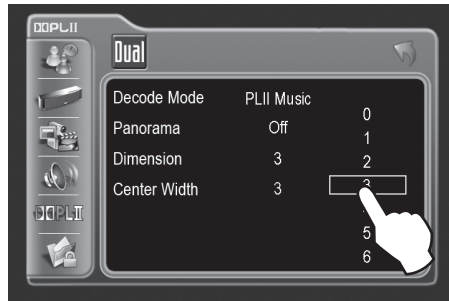

- 0
- 1
- 2
- 3 = DEFAULT
- 4
- 5
- 6

Changing the center width control allows adjustment of the center image so it may be heard only from the center speaker (if equipped), only from the Left/Right speakers as a "phantom" center image, or various combinations of all three front speakers.

Note: *PLII Music decode mode must be selected to adjust the dimension and center width.

DVD Setup Menu - Rating

Rating Setup Menu

With the monitor open in DVD mode, press the AREA A (top left screen) to display the MAIN menu. Press **DVD Setup** to access the DVD setup menu.

Note:

A DVD disc must be inserted to access these functions and features.

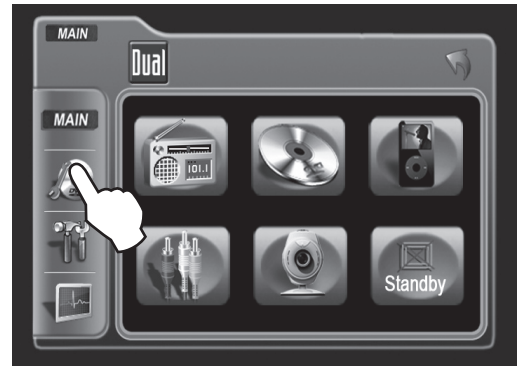

Press **RATING** icon to select from the following menus:

Enable Parental Lock Password

Press ---- to enter a password

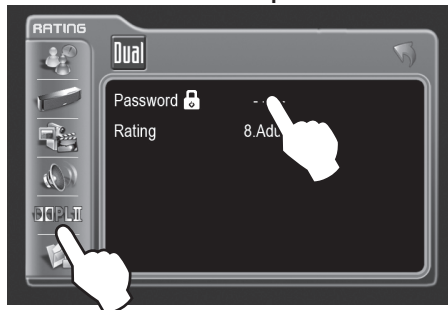

Setting Parental Lock Password

1. Enter a 4-digit code
2. Write the code down
3. Save in a safe place

Rating Setting

When unlock symbol is displayed, select desired rating

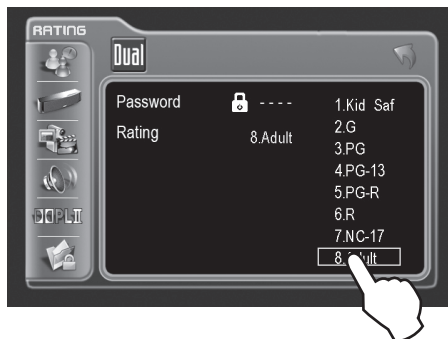

1. Kid Safe
2. G
3. PG
4. PG-13
5. PG-R
6. R
7. NC-17
8. Adult = DEFAULT

Parental Password Override

In the event you forget or loose your **PARENTAL LOCK** password, enter 9991.

CD Operation

CD User Interface

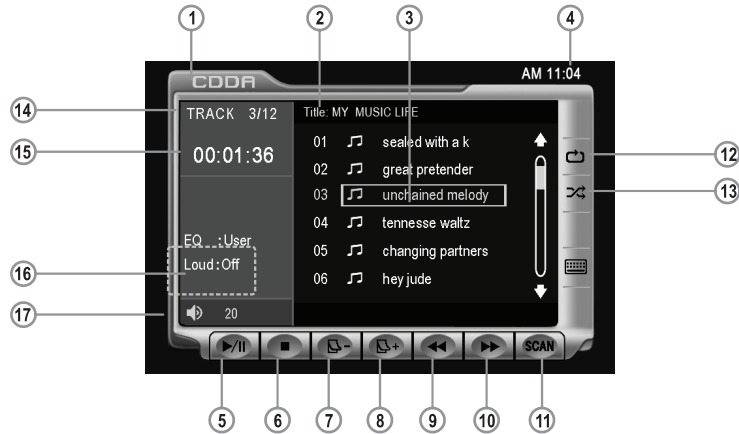

- 1) Current **MODE** information, touch upper left area to return to **MAIN MENU**
- 2) Disc title
- 3) Track title
- 4) Current **TIME**
- 5) Touch to **PLAY/PAUSE** disc playback
- 6) Touch to **STOP** disc playback
- 7) Touch to **PAGE** down
- 8) Touch to **PAGE** up
- 9) Touch to **FAST REVERSE** current track
- 10) Touch to **FAST FORWARD** current track
- 11) Touch to **SCAN** CD tracks for 10 seconds each track, touch again to deactivate
- 12) Touch to activate/deactivate **REPEAT**: Single mode
- 13) Touch to activate/deactivate **RANDOM** mode
- 14) Current track and total number of tracks on the disc
- 15) Elapsed playback time
- 16) Playback information
- 17) Volume indicator

CD Operation

Playing CD-DA discs

After inserting a CD disc, files will play in numerical order in the directory.



Selecting by Keypad

Touch to display keypad. Enter desired track number and press ok.



Selecting by Direct Track Access

Touch desired track for DIRECT TRACK access.



Previous/Next Page

Touch to view UP/DOWN pages of available TRACKS.

MP3/WMA Operation

MP3/WMA User Interface

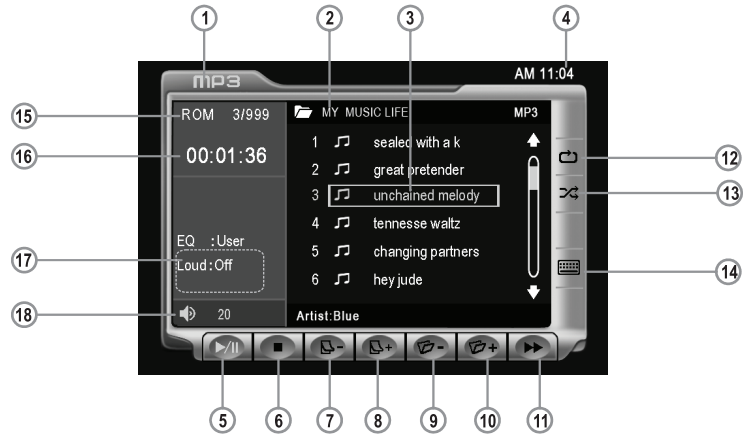

- 1) Current **MODE** information, touch upper left area to return to **MAIN MENU**
- 2) Disc title
- 3) Track title
- 4) Current **TIME**
- 5) Touch to **PLAY/PAUSE** disc playback
- 6) Touch to **STOP** disc playback
- 7) Touch to **PAGE** down
- 8) Touch to **PAGE** up
- 9) Touch to **PREVIOUS FOLDER**
- 10) Touch to **NEXT FOLDER**
- 11) Touch to **FAST FORWARD** MP3 tracks, touch **PLAY** to deactivate
- 12) Touch to activate/deactivate **REPEAT: Single** mode
- 13) Touch to activate/deactivate **RANDOM** mode
- 14) Touch to access the **DIRECT TRACK** access keypad
- 15) Current track and total number of tracks on the disc
- 16) Elapsed playback time
- 17) Playback information
- 18) Volume indicator

MP3/WMA Operation

Playing MP3/WMA files

After inserting an MP3/WMA disc, files will play in numerical order in the directory.



Selecting by Keypad

Touch to display keypad. Enter desired track number and press ok.



Selecting by Direct Track Access

Touch desired track for DIRECT TRACK access.



Previous/Next Page

Touch to view UP/DOWN pages of available TRACKS.



Media Compatibility

Media Compatibility

The following types of discs/files are compatible:

- CD-ROM (ISO), CD-R, CD-RW, DVD+R/RW, DVD-R/RW
- CD-DA, DVD Video
- MP3 data
- WMA data

The following types of discs/files are not compatible:

- WMA files that are protected by DRM (Digital Rights Management)
- WMA lossless format
- Discs recorded with Track At Once or packet writing
- MP3 PRO format
- MP3 playlists
- WAV format
- WMV format
- JPG format
- DivX format
- AVI format
- MPG format

Some recordable DVDs and CDs may be incompatible with this unit, depending on media type and recording method.

Playback Order

MP3/WMA playback sequence is based on recorded order of files and begins in the root folder of the disc. Any empty folders or folders that do not include MP3/WMA files are skipped. This unit may not play files in the order they were recorded in. Refer to your recording software's user's manual for more information.

Compatible Recording Formats

- ISO9660 level 1
- ISO9660 level 2
- Yellow Book MODE 1
- Yellow Book MODE 2 FORM 1
- Multi session
- Maximum files - 1500
- Maximum folder levels - 8
- MPEG-1/2 Audio Layer-3

ISO9660 standards:

- Maximum nested folder depth is 8 (including the root folder).
- Valid characters for folder/file names are letters A-Z (all caps), numbers 0-9, and "_" (underscore). Some characters may not be displayed correctly, depending on the character type.
- This device can play back discs in Joliet and other standards that conform to ISO9660. MP3/WMA written in the formats other than the above may not play and/or their file names or folder names may not be displayed properly.

Media Compatibility

Additional MP3/WMA Information

An internal buffer provides ESP (Electronic Skip Protection) to virtually eliminate skipping.

When playing a disc recorded with regular audio files (CD-DA or .WAV) and MP3/WMA files, the unit will play the MP3/WMA files only.

Only MP3 files with filename extension (.mp3) can be played.
Only WMA files with filename extension (.wma) can be played.

Do not attempt to play discs which contain non-MP3/WMA files with the MP3/WMA extension.

Sampling Frequency Rates

MP3 32kHz ~ 48kHz

WMA 32kHz ~ 48kHz

Transfer Bit rates

MP3 40kbps ~ 320kbps constant
Variable bit rates

WMA 40kbps ~ 192kbps constant
Variable bit rates

Note:

Some files may not play or be displayed correctly, depending on sampling rates and bit rates.

Recommended Settings

For best results, use the following settings when burning an MP3 disc:
128kbps or higher constant bit rate
44.1kHz or higher sampling frequency

For best results, use the following settings when burning a WMA disc:
64kbps or higher constant bit rate
44kHz or higher sampling frequency



Limited One Year Warranty

This warranty gives you specific legal rights. You may also have other rights which vary from state to state.

Dual Electronics Corp. warrants this product to the original purchaser to be free from defects in material and workmanship for a period of one year from the date of the original purchase.

Dual Electronics Corp. agrees, at our option, during the warranty period, to repair any defect in material or workmanship or to furnish an equal new, renewed or comparable product (whichever is deemed necessary) in exchange without charges, subject to verification of the defect or malfunction and proof of the date of purchase. Subsequent replacement products are warranted for the balance of the original warranty period.

Who is covered? This warranty is extended to the original retail purchaser for products purchased from an authorized Dual dealer and used in the U.S.A.

What is covered? This warranty covers all defects in material and workmanship in this product. The following are not covered: software, installation/removal costs, damage resulting from accident, misuse, abuse, neglect, product modification, improper installation, incorrect line voltage, unauthorized repair or failure to follow instructions supplied with the product, or damage occurring during return shipment of the product. Specific license conditions and copyright notices for the software can be found via www.dualav.com.

What to do?

1. Before you call for service, check the troubleshooting guide in your owner's manual. A slight adjustment of any custom controls may save you a service call.
2. If you require service during the warranty period, you must carefully pack the product (preferably in the original package) and ship it by prepaid transportation with a copy of the original receipt from the retailer to an authorized service center.
3. Please describe your problem in writing and include your name, a return UPS shipping address (P.O. Box not acceptable), and a daytime phone number with your shipment.
4. For more information and for the location of the nearest authorized service center please contact us by one of the following methods:
 - Call us toll-free at 1-866-382-5476
 - E-mail us at cs@dualav.com

Exclusion of Certain Damages: This warranty is exclusive and in lieu of any and all other warranties, expressed or implied, including without limitation the implied warranties of merchantability and fitness for a particular purpose and any obligation, liability, right, claim or remedy in contract or tort, whether or not arising from the company's negligence, actual or imputed. No person or representative is authorized to assume for the company any other liability in connection with the sale of this product. In no event shall the company be liable for indirect, incidental or consequential damages.

Troubleshooting

Problem	Cause	Action
Unit will not turn on (no power)	Yellow wire not connected or incorrect voltage Red wire not connected or incorrect voltage	Check connections for proper voltage (11~16VDC)
	Black wire not connected	Check connection to ground
	Fuse blown	Replace fuse
	Speaker wires not connected	Check connections at speakers
Unit has power (but no sound)	One or more speaker wires touching each other or touching chassis ground	Insulate all bare speaker wires from each other and chassis ground
	Yellow or red wire touching chassis ground	Check for pinched wire
Unit blows fuse	Speaker wires touching chassis ground	Check for pinched wire
	Incorrect fuse rating	Use fuse with correct rating
	Parking brake safety circuit not connected Parking brake not applied	Check connections at parking brake Apply parking brake
Unit has audio (but no video)	Reverse circuit not connected Vehicle is not in reverse	Check connections at reverse lamp Select reverse gear
DVD does not start playback	Physical defect in media	Check media for scratches
	Wrong region	Use discs labeled "Region 1" or "All" only.
IR remote does not work	Dead battery	Replace battery
Excessive skipping	Unit is not mounted correctly	Check mounting sleeve
	Physical defect in media	Check media for scratches
Bad Disc appears on display	Focus error or disc is in upside down	Press eject or RESET
Incorrect Region Code appears on display	Region code error	Use only DVDs labeled "Region 1" or "All" only.
Front panel will not open/close	Front panel obstructed	Remove the obstacle and press OPEN again to resume the monitor open/close sequence.



Specifications

DVD Player	Frequency response: 10Hz-20kHz Channel separation @ 1kHz: >65dB D/A converter: 24 Bit
FM Tuner	Tuning range: 87.5MHz-107.9MHz Usable sensitivity: 8.5dBf 50dB quieting sensitivity: 10dBf Stereo separation @ 1kHz: 40dB Frequency response: 30Hz-13kHz
AM Tuner	Tuning range: 530kHz-1710kHz Usable sensitivity: 22uV Frequency response: 30Hz-2.2kHz
Monitor	Panel size: 7" (177.8 mm) diagonal measurement View angle (up/down/left/right): 30/60/60/60 Resolution: 480 W x 234 H Brightness (cd/m ²): 350 Contrast ratio: 300:1 Elements: 336,960
General	Operating voltage: 11-16 VDC, negative ground Speaker output impedance: 4~8 ohms Line output voltage: 2 Volts Line output impedance: 200 ohms Chassis dimensions: 7" x 7" x 2" (178 x 178 x 51 mm)

Design and specifications subject to change without notice.



CEA-2006 Power Standard Specifications
(reference: 14.4VDC +/- 0.2V, 20Hz~20kHz)

Power Output: 17 Watts RMS x 4 channels at 4 ohms and $\leq 1\%$ THD+N
Signal to Noise Ratio: 80dBA (reference: 1 watt into 4 ohms)





Dual Electronics Corp.
Toll Free: 1-866-382-5476

www.dualav.com

©2010 Dual Electronics Corp. All rights reserved.

NSA0110-V03

Printed in China